

---

Hexalobular drive / Torx®

Higher torque transfer



Higher torque transfer  
Low wear  
Low contact forces  
No «cam-out» effect

# Content

---

Technical Advantages and Economical Benefits	4
Standards	6
Screwdriver	15
Autosert®	17
Torx plus®	17
Other fasteners for facades and timber construction	18

## TECHNICAL ADVANTAGES, ECONOMICAL BENEFITS

# Hexalobular screws to ISO 10664

---

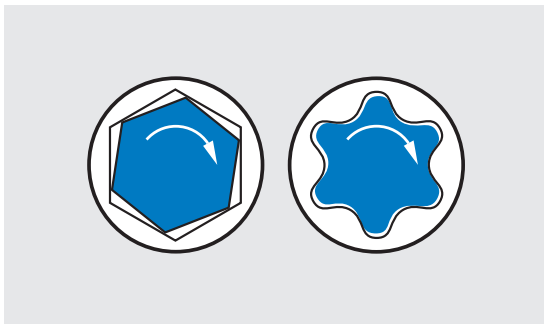

### Higher torque transfer

The driving forces are transferred through surfaces rather than through edges. This results in less wear and tear on tools and no damage to the surface treatment – the corrosion protection is preserved.

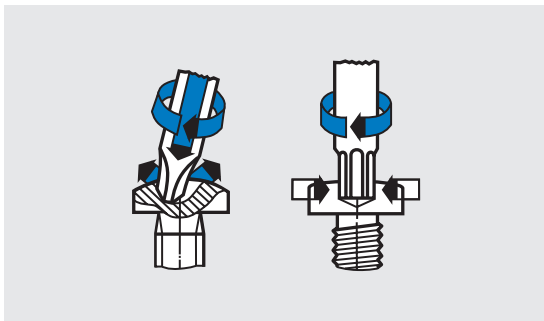

### Longer tool life

The optimal torque transmission extends the working life of screwdriving tools. This leads to considerable cost savings, above all when working with small screws or socket set screws. There is no «came out» effect typical with cross recess drive screws.

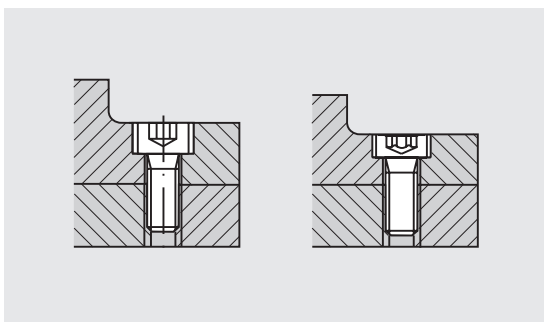

### Low clearance requirement

The screw's small head requires less space, yet it can absorb the induced load.

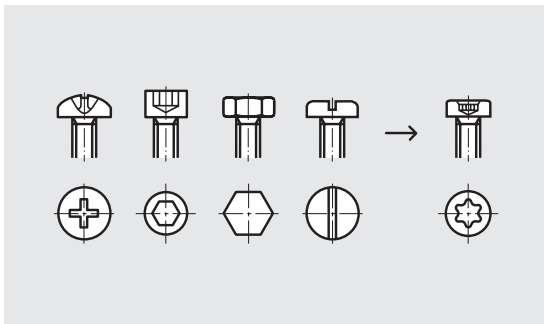

### Large potential for rationalisation

One type of drive can be used for many different types of screw. This particularly applies to the size range up to M8. The product range used can be reduced. The logical result is less outlay on assembly tools and reduced storage and logistics costs.

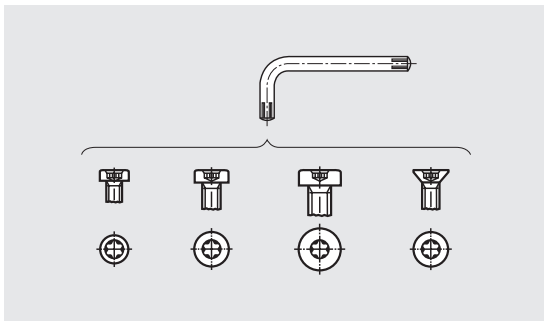

### Wide range of use

The high torque transmission opens up new possibilities for special shapes – a tool for different dimensions. Problems associated with installing low head or flat head screws are virtually eliminated.



### Worldwide application

Hexalobular drive/Torx® screws have gained world wide acceptance – in the automobile industry, telecommunications, appliance industries, and in many other industry segments.

## STANDARDS

# Hexalobular / Torx® screws

Hexalobular socket flat head screws with special low head

○ **BN 9524** | Steel 8.8, zinc plated blue, ○ **BN 20146** | Stainless steel A2

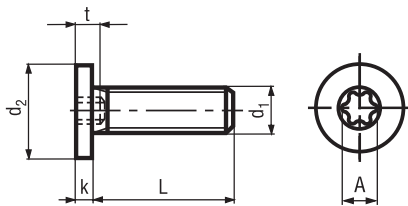

d <sub>1</sub>	M2	M2,5	M3	M4	M5	M6	M8	M10
d <sub>2</sub>	4	5	6	8	9	10	13	16
k	1,2	1,3	1,3	1,5	1,5	1,5	1,5	1,5
⊙	X5	X6	X8	X10	X15	X20	X25	X30
t max.	0,9	1	1,1	1,5	1,8	2,1	2,4	2,7
A	1,5	1,8	2,4	2,8	3,4	3,9	4,5	5,6

d <sub>1</sub>	M2	M2,5	M3	M4	M5	M6	M8	M10
4	○	○						
5	○	○	○○	○				
6	○	○	○○	○○	○○			
8	○	○	○○	○○	○○	○○	○○	
10			○○	○○	○○	○○	○○	○
12			○	○○	○○	○○	○○	○
16			○	○	○○	○○	○○	○
20			○	○	○	○○	○○	○
25					○	○	○	○
30						○	○	○

Hexalobular socket flat head screws with low head **ISO 14580**

○ **BN 4850** | Steel 8.8, zinc plated blue, ○ **BN 15857** | Stainless steel A2

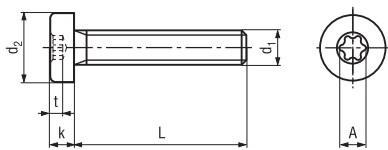

d <sub>1</sub>	M2	M2,5	M3	M4	M5	M6	M8
d <sub>2</sub> max.	3,8	4,5	5,5	7	8,5	10	13
k max.	1,55	1,85	2,4	3,1	3,65	4,4	5,8
⊙	X6	X8	X10	X20	X25	X30	X45
t max.	0,84	0,91	1,27	1,66	1,91	2,29	3,05
A	1,75	2,4	2,8	3,95	4,5	5,6	7,95

d <sub>1</sub>	M2	M2,5	M3	M4	M5	M6	M8
3	○	○					
4	○	○	○				
5	○	○	○○	○			
6	○	○	○○	○○	○		
8	○	○	○○	○○	○○	○○	
10	○	○	○○	○○	○○	○○	○
12	○	○	○○	○○	○○	○○	○
16	○	○	○○	○○	○○	○○	○
20			○○	○○	○○	○○	○
25			○○	○○	○○	○○	○
30			○	○○	○○	○○	○
35					○	○○	○
40					○	○○	○
45						○	
50						○	○

Subject to change without notice. Please refer to your local Bossard E-Shop for the current assortment and dimensions.  
Other variants upon request.

## Hexalobular socket button head cap screw ~ISO 7380

○ **BN 6404** | Steel 8.8, zinc plated blue

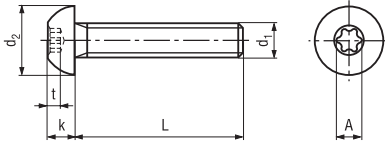

d <sub>1</sub>	M2	M2,5	M3	M4	M5	M6	M8
d <sub>2</sub> max.	3,5	4,7	5,7	7,6	9,5	10,5	14
k max.	1,3	1,5	1,65	2,2	2,75	3,3	4,4
☉	X6	X8	X10	X20	X25	X30	X40
t max.	0,8	0,92	1	1,4	1,6	1,9	2,6
A	2	2,4	2,8	3,9	4,5	5,6	6,8

d <sub>1</sub>	M2	M2,5	M3	M4	M5	M6	M8
3	○						
4	○	○	○				
5	○	○	○	○			
6	○	○	○	○	○		
8	○	○	○	○	○	○	
10	○	○	○	○	○	○	○
12	○	○	○	○	○	○	○
14				○	○	○	
16		○	○	○	○	○	○
20			○	○	○	○	○
25			○	○	○	○	○
30			○	○	○	○	○
35				○		○	○
40				○	○	○	○
45					○		
50						○	○

## Hexalobular socket pan head cap screw ISO 14583

○ **BN 5687** | Stainless steel A2, ● **BN 20038** | Stainless steel A4

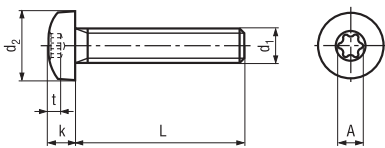

d <sub>1</sub>	M1,6	M2	M2,5	M3	M4	M5	M6	M8
d <sub>2</sub> max.	3,2	4	5	5,6	8	9,5	12	16
k max.	1,4	1,6	2,1	2,4	3,1	3,7	4,6	6
☉	X5	X6	X8	X10	X20	X25	X30	X45
t max.	0,6	0,77	1,04	1,27	1,66	1,91	2,42	3,18
A	1,49	1,75	2,4	2,8	3,95	4,5	5,6	7,95

d <sub>1</sub>	M1,6	M2	M2,5	M3	M4	M5	M6	M8
3	●	○●	○●					
4	●	○●	○●	●				
5	●	○●	○●	○●				
6	●	○●	○●	○●	○●	○●		
8	●	○●	○●	○●	○●	○●	○●	
10	●	○●	○●	○●	○●	○●	○●	○
12	●	○●	○●	○●	○●	○●	○●	○
16	●	○●	○●	○●	○●	○●	○●	○
20		○●	○●	○●	○●	○●	○●	○
25			○●	○●	○●	○●	○●	○
30				○●	○●	○●	○●	○
35				○●	○●	○●	○●	○
40				○●	○●	○●	○●	○
45					○●	○●	○●	○
50					○●	○●	○●	○
60						○●	○●	○

Subject to change without notice. Please refer to your local Bossard E-Shop for the current assortment and dimensions. Other variants upon request.

## Countersunk screws ISO 14581

○ **BN 4851** | Steel 8.8, zinc plated blue, ○ **BN 3803** | Stainless steel A2, ● **BN 5687** | Stainless steel A4

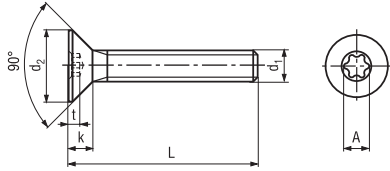

d <sub>1</sub>	M2	M2,5	M3	M4	M5	M6	M8
d <sub>2</sub> max.	3,8	4,7	5,5	8,4	9,3	11,3	15,8
k max.	1,2	1,5	1,65	2,7	2,7	3,3	4,65
☉	X6	X8	X10	X20	X25	X30	X45
t max.	0,64	0,79	0,83	1,53	1,51	1,78	2,54
A	1,75	2,4	2,8	3,95	4,5	5,6	7,95

d <sub>1</sub>	M2	M2,5	M3	M4	M5	M6	M8
4	○●	○●	○●				
5	○●	○●	○●	○●			
6	○●	○●	○●	○●	○●		
8	○●	○●	○●	○●	○●	○●	
10	○●	○●	○●	○●	○●	○●	○
12	○●	○●	○●	○●	○●	○●	○●
16	○●	○●	○●	○●	○●	○●	○●
L 20		○●	○●	○●	○●	○●	○●
25			○●	○●	○●	○●	○●
30			○●	○●	○●	○●	○●
35				○●	○●	○●	○●
40				○●	○●	○●	○●
45					○●	○●	○●
50					○●	○●	○●
60						○●	

## Socket set screws with chamfered point ~DIN 913

○ **BN 11493** | Steel 45 H, zinc plated blue, ○ **BN 13270** | Steel 45 H, zinc flake coated

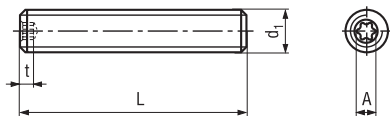

d <sub>1</sub>	M3	M4	M5	M6
☉	X6	X8	X10	X15
t min.	0,9	1,2	1,5	1,8
t max.	1,3	1,6	2	2,3
A	1,7	2,4	2,8	3,4

d <sub>1</sub>	M3	M4	M5	M6
3	○	○		
4	○	○	○	○
6	○	○	○	○
8	○	○	○	○
L 10	○	○	○	○
12		○	○	○
16			○	○
20				○

Subject to change without notice. Please refer to your local Bossard E-Shop for the current assortment and dimensions.  
Other variants upon request.



## Socket set screws with cup point ~DIN 916

○ **BN 1536** | Steel 45 H, zinc plated blue, ○ **BN 4737** | Steel 45 H, zinc flake coated

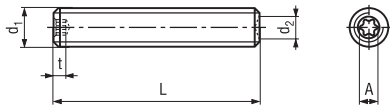

d <sub>1</sub>	M3	M4	M5	M6
d <sub>2</sub>	1,15-1,4	1,75-2	2,25-2,5	2,75-3
⊙	X6	X8	X10	X15
t	min. 0,9	1,2	2	1,8
	max. 1,3	1,6	2	2,3
A	1,7	2,4	2,8	3,4

d <sub>1</sub>	M3	M4	M5	M6
3	○	○		
4	○	○	○	○
6	○	○	○	○
8	○	○	○	○
10	○	○	○	○
12		○	○	○
16			○	○
20				○

## Pan head screws ecosyn-fix®

○ **BN 5128** | Steel 4.8, zinc plated blue, ○ **BN 10649** | Stainless steel A2

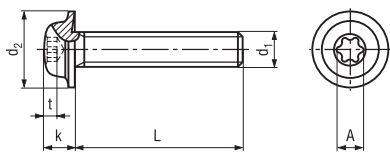

d <sub>1</sub>	M2,5	M3	M4	M5	M6
d <sub>2</sub> max.	6,5	8	10	12	14
k max.	2,3	2,7	3,4	4,2	4,9
⊙	X8	X10	X20	X25	X30
t	min. 0,8	1	1,3	1,5	1,9
	max. 1	1,3	1,7	1,9	2,3
A	2,4	2,8	3,9	4,5	5,6

d <sub>1</sub>	M2,5	M3	M4	M5	M6
3	○				
4	○○	○			
5	○○	○	○		
6	○○	○○	○○	○	
8	○○	○○	○○	○○	○
10	○○	○○	○○	○○	○
12	○○	○○	○○	○○	○○
16	○	○	○○	○○	○○
20	○	○	○○	○○	○○
25		○	○	○○	○○
30		○	○	○	○○

Subject to change without notice. Please refer to your local Bossard E-Shop for the current assortment and dimensions. Other variants upon request.

## Thread forming pan head screws head ~DIN 7985

With metric thread trilobular

○ **BN 13916** | case-hardened steel zinc plated blue, waxed, ○ **BN 5653** | Stainless steel A2, waxed

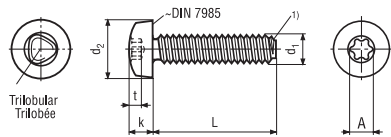

d <sub>1</sub>	M2	M2,5	M3	M4	M5	M6	M8
d <sub>2</sub> max.	4	5	6	8	10	12	16
k max.	1,72	2,12	2,52	3,25	3,95	4,75	6,15
⊙	X6	X8	X10	X20	X25	X30	X40
t max.	0,8	1,2	1,3	1,8	2	2,4	3,3
A	1,8	2,4	2,8	3,9	4,5	5,6	6,8

<sup>1)</sup> cone-shaped point max. 4P

d <sub>1</sub>	M2	M2,5	M3	M4	M5	M6	M8
3	○						
4	○	○○					
5	○	○○	○○				
6	○	○○	○○	○○			
8	○	○○	○○	○○	○○		
10	○	○○	○○	○○	○○	○○	
L 12	○	○○	○○	○○	○○	○○	
16		○	○○	○○	○○	○○	○
20		○	○○	○○	○○	○○	○
25			○	○○	○○	○○	○
30			○	○○	○○	○○	○
35				○	○	○	○
40				○	○	○	○

## Thread-forming countersunk screws DIN 7500 head ~DIN 965

With metric thread trilobular

○ **BN 11288** | case-hardened steel zinc plated blue, waxed, ○ **BN 13278** | Stainless steel A2, waxed

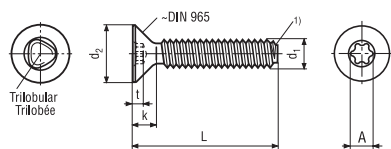

d <sub>1</sub>	M2	M2,5	M3	M4	M5	M6	M8
d <sub>2</sub> max.	3,8	4,7	5,6	8,4	9,3	11,3	14,5
k max.	1,2	1,5	1,65	2,2	2,5	3	4
⊙	X6	X8	X10	X20	X25	X30	X40
t max.	0,7	1	1	1,5	1,5	1,9	3,3
A	1,8	2,4	2,8	3,9	4,5	5,6	6,8

<sup>1)</sup> cone-shaped point max. 4P

d <sub>1</sub>	M2	M2,5	M3	M4	M5	M6	M8
3	○						
4	○	○					
5	○	○○					
6	○	○○	○○				
8	○	○○	○○	○○	○		
10	○	○○	○○	○○	○○	○○	
L 12	○	○○	○○	○○	○○	○○	○
16		○	○○	○○	○○	○○	○
20			○○	○○	○○	○○	○
25			○	○○	○○	○○	○
30				○○	○○	○○	○
35							○
40							○

Subject to change without notice. Please refer to your local Bossard E-Shop for the current assortment and dimensions.  
Other variants upon request.

## Thread-forming pan head screws **DIN 7500** with nibs head ~DIN 7985

With metric thread trilobular

○ **BN 14551** | case-hardened steel zinc plated blue, waxed, with hexalobular recess and slot

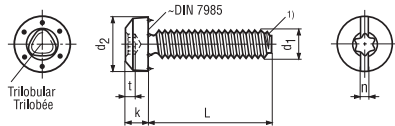

d <sub>1</sub>	M3	M4
d <sub>2</sub> max.	6	8
k max.	2,52	3,25
n	0,6	1
⊕	X10	X20
t max.	1,2	1,9

d <sub>1</sub>	M3	M4
5	○	
6	○	○
8	○	○
L		○
10		○
12		○
16	○	

<sup>1)</sup> cone-shaped point max. 4P

## Thread-forming pan head screws SHEETtracs **WN 5251** head

○ **BN 20191** | case-hardened steel zinc plated blue

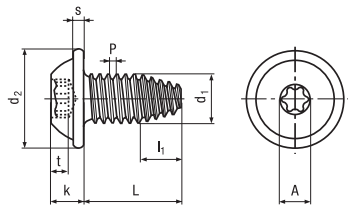

d	30	35	40	50	60
d <sub>1</sub>	3	3,5	4	5	6
P (M)	0,5	0,6	0,7	0,8	1
l <sub>1</sub> max.	3,9	4,6	5	5,9	7,1
d <sub>2</sub>	7,5	9	10	11,5	14,5
s	0,6	0,7	1	1,3	1,5
k	2,25	2,5	3	3,6	4,4
⊕	T10	T15	T20	T25	T30
A~	2,8	3,35	3,95	4,5	5,6
t min.	1	1,1	1,25	1,6v	2
t max.	1,3	1,4	1,7	2	2,4

d	30	35	40	50	60
6	○				
8	○	○	○		
10	○	○	○	○	
L	○	○	○	○	○
12		○	○	○	○
14		○	○	○	○
16			○	○	○
20				○	○
25					○

Subject to change without notice. Please refer to your local Bossard E-Shop for the current assortment and dimensions. Other variants upon request.

## Pan head self-drilling screws with tip form C ISO 14585

○ **BN 13274** | case-hardened steel zinc plated blue, ○ **BN 9995** | Stainless steel A2

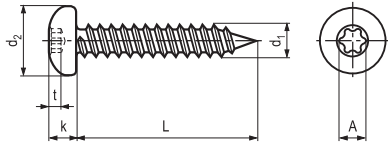

d <sub>1</sub>	ST2,2	ST2,9	ST3,5	ST3,9	ST4,2	ST4,8	ST5,5	ST6,3
d <sub>2</sub> max.	4,2	5,6	7	7,5	8	9,5	11	12
k max.	1,8	2,4	2,6	2,8	3,1	3,7	4	4,6
☉	X6	X10	X15	X15	X20	X25	X25	X30
t max.	0,8	1,27	1,4	1,4	1,8	2,03	2,03	2,42
A	1,8	2,8	3,35	3,5	3,35	4,5	4,5	5,6

d <sub>1</sub>	ST2,2	ST2,9	ST3,5	ST3,9	ST4,2	ST4,8	ST5,5	ST6,3
4,5	○	○						
6,5	○	○○	○○					
9,5	○	○○	○○	○○	○○	○○		
13	○	○○	○○	○○	○○	○○	○○	○○
16	○	○○	○○	○○	○○	○○	○○	○○
19		○○	○○	○○	○○	○○	○○	○○
L 22		○○	○○	○○	○○	○○	○○	○○
25		○○	○○	○○	○○	○○	○○	○○
32		○	○○	○○	○○	○○	○○	○○
38			○	○	○○	○○	○○	○○
45					○	○	○○	○○
50						○	○○	○○
60							○	○

## Flat head tapping screw with tip form C ISO 14586

○ **BN 11255** | case-hardened steel zinc plated blue, ○ **BN 15856** | Stainless steel A2

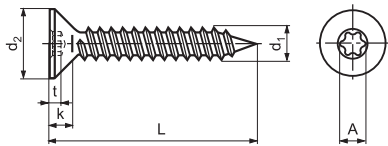

d <sub>1</sub>	ST2,2	ST2,9	ST3,5	ST3,9	ST4,2	ST4,8	ST5,5	ST6,3
d <sub>2</sub> max.	4,3	5,5	7,3	7,5	8,4	9,3	10,3	11,3
k max.	1,3	1,7	2,35	2,55	2,6	2,8	3	3,15
☉	X6	X10	X15	X15	X20	X25	X25	X30
t max.	0,8	0,91	1,3	1,4	1,58	1,78	2,03	2,42
A	1,8	2,8	3,35	3,35	3,95	4,5	4,5	5,6

d <sub>1</sub>	ST2,2	ST2,9	ST3,5	ST3,9	ST4,2	ST4,8	ST5,5	ST6,3
4,5	○							
6,5	○	○○						
9,5	○	○○	○○	○○	○			
13	○	○○	○○	○○	○○	○○	○○	○
16	○	○○	○○	○○	○○	○○	○○	○○
19		○○	○○	○○	○○	○○	○○	○○
L 22		○○	○○	○○	○○	○○	○○	○○
25		○○	○○	○○	○○	○○	○○	○○
32		○○	○○	○○	○○	○○	○○	○○
38			○○	○○	○○	○○	○○	○○
45				○○	○○	○○	○○	○○
50					○○	○○	○○	○○
60						○	○	○

Subject to change without notice. Please refer to your local Bossard E-Shop for the current assortment and dimensions.  
Other variants upon request.

## PT®-screws pan head Torx plus® / Autosert® WN 1452

○ **BN 13265** | hardened and tempered steel, zinc plated blue

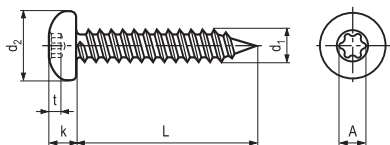

Nenn-Ø	K20	K22	K25	K30	K35	K40
d <sub>1</sub>	2	2,2	2,5	3	3,5	4
d <sub>2</sub>	3,6	4	4,2	5,6	6,9	7,5
k	1,5	1,4	1,6	2,1	2,3	2,6
⊙	6 IP	6 IP	8 IP	10 IP	15 IP	20 IP
t	min. 0,65	0,65	0,7	1	1,1	1,3
	max. 0,8	0,8	0,9	1,3	1,4	1,65
A	1,75	1,75	2,4	2,8	3,35	3,95

d <sub>1</sub>	K20	K22	K25	K30	K35	K40
5	○	○				
6	○	○	○	○		
8	○	○	○	○	○	○
10	○	○	○	○	○	○
L		○	○	○	○	○
12						
16		○	○	○	○	○
20					○	○
25					○	○
30					○	○

## PT®-screws countersunk head Torx plus® / Autosert® WN 1423

○ **BN 11308** | hardened and tempered steel, zinc plated blue

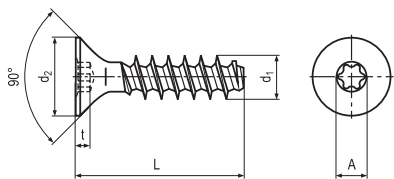

Nenn-Ø	K22	K25	K30	K35
d <sub>1</sub>	2,2	2,5	3	3,5
d <sub>2</sub>	3,8	4,7	5,5	7,3
⊙	6 IP	8 IP	8 IP	15 IP
t	min. 0,65	0,7	0,85	0,95
	max. 0,8	0,9	1,1	1,2
A	1,75	2,4	2,4	3,35

d <sub>1</sub>	K22	K25	K30	K35
6	○	○		
8	○	○	○	
L	○	○	○	○
10				
12		○	○	○
16			○	○

Subject to change without notice. Please refer to your local Bossard E-Shop for the current assortment and dimensions. Other variants upon request.

Delta PT®-screws pan head Torx plus® / Autosert® WN 5452 **WN 5451**  
with pressed on washer

○ **BN 20040** | hardened and tempered steel, zinc plated blue, ○ **BN 20165** | Stainless steel A2

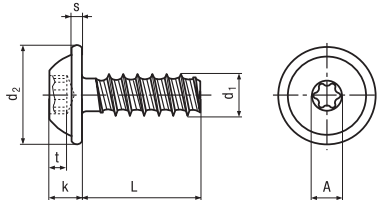

Nenn-Ø	22	25	30	35	40	50	60
d <sub>1</sub>	2,2	2,5	3	3,5	4	5	6
d <sub>2</sub>	5	5,5	6,5	7,5	9	11	13,5
k	1,6	1,9	2,3	2,7	3,1	3,5	4,2
s	0,6	0,7	0,8	0,9	1	1,2	1,4
☉	6 IP	8 IP	10 IP	15 IP	20 IP	25 IP	30 IP
t	min.	0,65	0,8	1	1,1	1,4	1,9
	max.	0,85	1	1,3	1,5	1,8	2,4
A	1,75	2,4	2,8	3,35	3,95	4,5	5,6

Nenn-Ø	22	25	30	35	40	50	60
5	○						
6	○	○					
8	○	○○	○○	○			
10	○	○○	○○	○	○○		
12		○○	○○	○	○○	○	
14			○○	○	○○	○	○
L			○○	○	○○	○	○
16			○		○○	○	○
18			○		○	○	○
20			○○	○	○○	○	○○
25			○○	○	○○	○	○
30						○	○
35							○○

Delta PT®-screws pan head Torx plus® / Autosert® WN 5452 **WN 5452**

○ **BN 20166** | Stainless steel A2

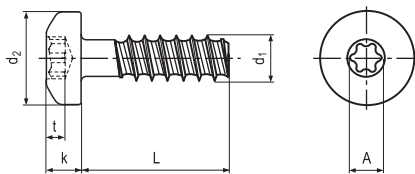

Nenn-Ø	25	30	35	40	50
d <sub>1</sub>	2,5	3	3,5	4	5
d <sub>2</sub>	4,4	5,3	6,1	7	8,8
k	1,9	2,3	2,7	3,1	3,5
☉	8 IP	10 IP	15 IP	20 IP	25 IP
t	min.	0,8	1	1,4	1,5
	max.	1	1,3	1,5	1,8
A	2,4	2,8	3,35	3,95	4,5

Nenn-Ø	25	30	35	40	50
8	○	○	○		
10	○	○	○	○	
12	○	○	○	○	
L		○	○	○	
14		○	○	○	
16		○	○	○	
20		○	○	○	○
25		○	○	○	

Subject to change without notice. Please refer to your local Bossard E-Shop for the current assortment and dimensions.  
Other variants upon request.

Screwdriver 1/4" bits for screws with hexalobular (Torx®)

○ **BN 31518** | hardened and tempered steel, plain, length 25 mm, short design



Größen

X5	○
X6	○
X8	○
X10	○
X15	○
X20	○
X25	○
X30	○
X40	○
X45	○
X50	○

Screwdriver 1/4" bits for screws with hexalobular (Torx plus®)

○ **BN 15096** | hardened and tempered steel, plain, length 25 mm, short design



Größen

6 IP	○
8 IP	○
10 IP	○
15 IP	○
20 IP	○
25 IP	○
30 IP	○

Screwdriver 1/4" bits product range for screws with hexalobular (Torx®)

○ **BN 20007** | hardened and tempered steel, plain, length 25 mm, short design

Contents: 1 bitholder and 1 bit each

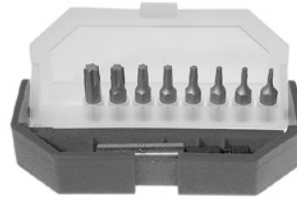

Größen

X6	○
X8	○
X10	○
X15	○
X20	○
X25	○
X30	○
X40	○

Allen key for screws with internal six lobe recess

○ **BN 14056** | hardened and tempered steel, black



Größen

X6	○
X8	○
X10	○
X15	○
X20	○
X25	○
X30	○
X40	○
X45	○

Subject to change without notice. Please refer to your local Bossard E-Shop for the current assortment and dimensions. Other variants upon request.



## Autosert®

The advantages of Autosert®  
Autosert® was specially developed for use in automated assembly.

The compound angle of the Autosert® feature guide the driver bit into the recess, creating a self-centering and engaging action. A perfect solution for the automated assembly where the driver bit continuously rotates.

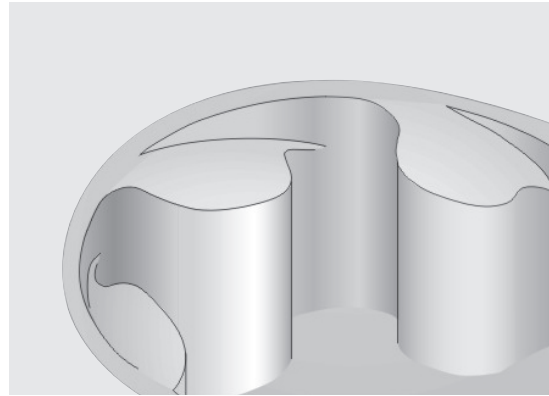

## Torx plus®

The hexalobular ISO 10664 (Torx®) is defined by radii, the Torx plus® by ellipses.





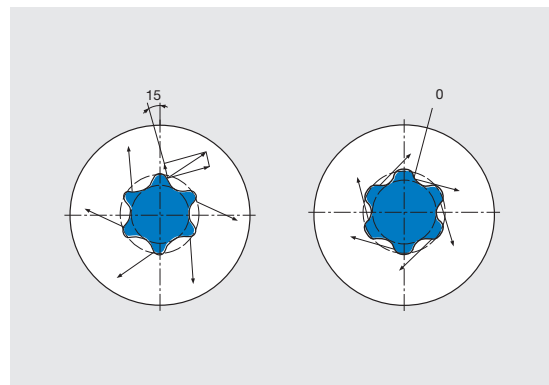

The actual drive angle is reduced from 15° to 0°. The torque transfer is used entirely to turn the screw. The advantages of the Torx plus® geometry can be best utilised by using the appropriate bits (BN 15096).

Tools for hexalobular screws (Torx®) are compatible with the Torx plus® screw drive.

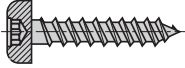
- durability of screwdriver bits increases by up to 4 times
- the increased screwdriver bit strength allows increased torque even when loosening the screw later on.

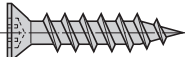
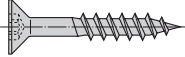
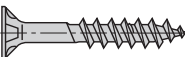
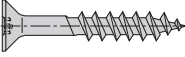

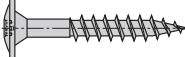
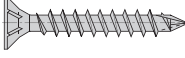
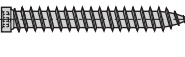
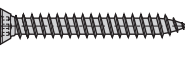
## Other fasteners for facades and timber construction

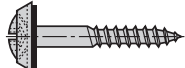
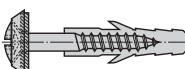
Description	Standard		Steel	Finish	BN	Ø	Stainless Steel	BN	Ø
<b>Screwing with timber</b>									
Pan head chipboard screws fully threaded	Spax®-S		case-hardened	yellow-galvanized, waxed	14340	3,5-6			
Flat head chipboard screws with standard thread	Spax®		case-hardened	yellow-galvanized waxed	14073	3-5			
				blue galvanized waxed	20183	3-6			
Flat head chipboard screws fully threaded							A2	50034	3-4
Flat head chipboard screws partially threaded							A2	50035	3-8
Flat head chipboard screws partially threaded	Spax®						A2 grade steel, waxed	15002	3,5-6
Flat head chipboard screws partially threaded (serrated from Ø 4)	Spax®		case-hardened	yellow-galvanized waxed	6952	3-12			
				blue galvanized waxed	20184	3-6			
Flat head chipboard screw product range partially threaded	Spax®-S		case-hardened	yellow-galvanized waxed	14306	3,5-6			
Round washer head chipboard screws partially threaded	Spax®		case-hardened	yellow-galvanized waxed	20035	8-10			
Flat head chipboard screws with CUT tips and milling ribs	Spax®-S		case-hardened	yellow-galvanized waxed	20161	8-12	A2 grade steel, waxed	20036	4,5-5
Frame anchor with cheesehead	Spax®-RA		case-hardened	yellow-galvanized	15929	7,5			
				zinc plated blue	20216				
Frame anchor with flat-countersunk head	Spax®-RA		case-hardened	yellow-galvanized	15930	7,5			
				zinc plated blue	20217				
Timber self-drilling screws with serration/ribbings under head			case-hardened	blue galvanized waxed	50150	4			
Timber self-drilling screws with serration and head, white coated RAL 9010			case-hardened	blue galvanized waxed	50151	4			
<b>Building screws</b>									
Lens headed countersunk building screws Torx® slotted, assembled with sealing ring and flat neoprene washer							A2	54420	4,5-5
							A2 grade steel copper-plated	54421	4,5-5
Building screws with hexalobular recess and slot, premounted dowel and sealing washer							A2	54422	4,5
							A2 grade steel copper-plated	54423	4,5

For detailed information, dimensions and specifications see the screws catalogue or visit our homepage.

## PROVEN PRODUCTIVITY – A PROMISE TO OUR CUSTOMERS

# The strategy for success

---

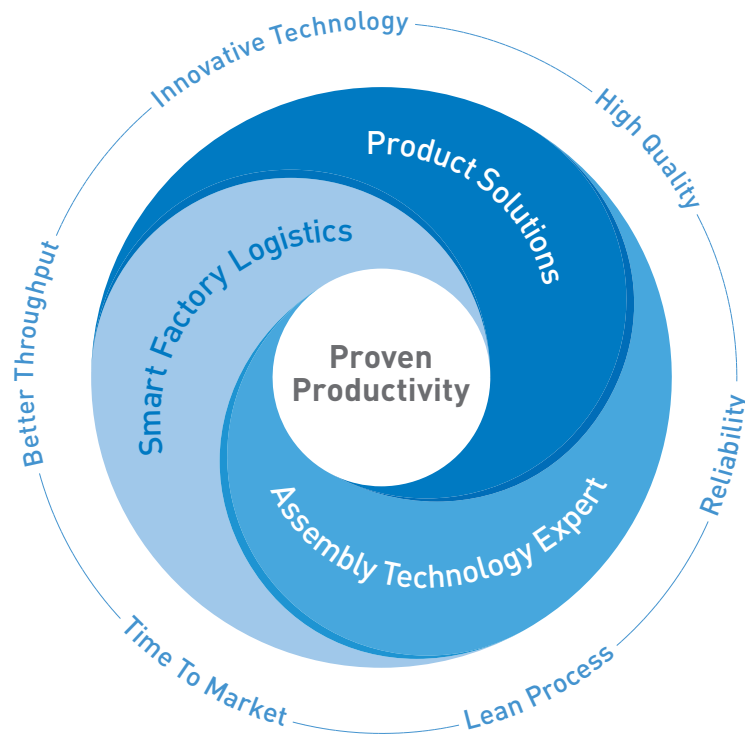

From years of cooperation with our customers we know what achieves proven and sustainable impact. We have identified what it takes to strengthen the competitiveness of our customers. Therefore we support our customers in three strategic core areas.

Firstly, when finding optimal **Product Solutions**, that is in the evaluation and use of the best fastening part for the particular function intended in our customers' products.

Second, our **Assembly Technology Expert** services deliver the smartest solutions for all possible fastening challenges. Our services cover from the moment our customers developing a new product, to

assembly process optimization as well as fastening technology education for our customers' employees.

And thirdly, optimising our clients' productions in a smart and lean way with **Smart Factory Logistics**, our methodology, with intelligent logistics systems and tailor-made solutions.

Understood as a promise to our customers, "Proven Productivity" contains two elements: Firstly, that it demonstrably works. And secondly, that it sustainably and measurably improves the productivity and competitiveness of our customers.

And this for us is a philosophy which motivates us every day to always be one step ahead.

---

[www.bossard.com](http://www.bossard.com)