

BOSSARD

Proven Productivity



ecosyn[®] - grip

Loosening safeguard at full load-bearing capacity



«ecosyn®-grip stands for functionality, safety and design.»

ecosyn®-grip

Loosening safeguard at full load-bearing capacity

ecosyn®-grip combines the process reliability of an internal drive with the loosening safeguard of a ribbed washer and the load-bearing capacity of an 8.8 screw.

Loosening safeguard

Screw connections that are exposed to dynamic forces such as shocks, impacts, transverse stresses or vibrations often have an increased risk of loosening. That is why additional washers with or without ribbing or spring washers are often used to increase the underhead friction and thus improve the safety against loosening.

ecosyn®-grip combines the wide contact surface of a button socket head with locking teeth. The locking teeth anchor in the softer surface material of the component to prevent a counterclockwise rotation. This ensures that up to 80% of the preload force is retained after the screw connection is made, without requiring an additional securing element.

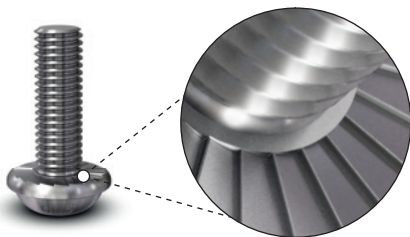

Recess at the transition of the screw shaft to the screw head to increase the load-bearing capacity

The advantages

- Loosening safeguard without additional elements
- Large area coverage for large through-holes
- Process reliable and automated processing
- Elegant head design
- Full load-bearing capacity of an 8.8 screw
- Reduced settling due to the reduced number of joints compared to a screw with an additional lock washer

Process reliability

ecosyn®-grip has an internal hexalobular drive and is thus suitable for manual and automated assembly using motor-driven tightening tools.

Due to the optimized contact surface, the internal hexalobular drive has low tool wear and a secure attachment of the screw. The tool slipping and wobbling movements are reliably prevented.

Additional securing elements, such as washers can be done away with, an incorrect assembly is ruled out, which additionally increases the process reliability.

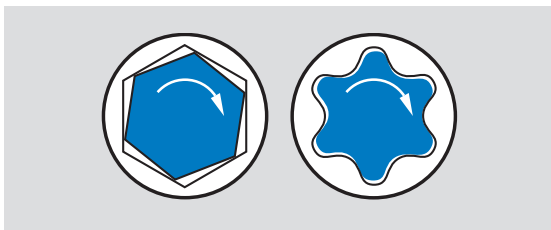
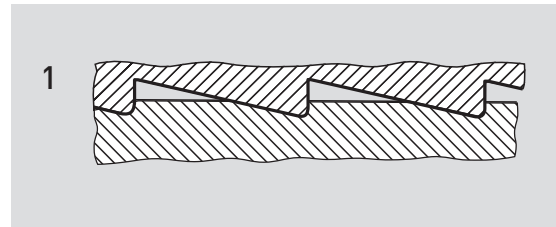
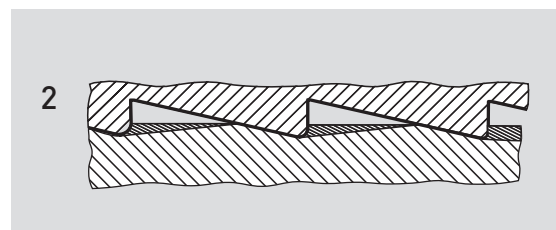

Illustration of the larger contact surface of the internal hexalobular socket drive compared to a hexagon socket

Functional principle of locking teeth



Tightening: Locking teeth lightly engage in the bearing surface



Loosening: Locking teeth rub off the surface lightly

Specifications of an ecosyn®-grip screw, type SF (serrated flange)

Tightening torque M_A [Nm] and achievable preload forces F_M [kN] for ecosyn®-grip screws with a 90% utilization of the yield point $R_{p0,2}$

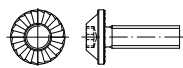
Serrated flange	Mating Material	Friction coeff. $\sim\mu_6$	Standard tightening torques max. M_A [Nm]			
			M5	M6	M8	M10
 BN 219 Strength class 8.8	Steel R_m \sim 500 to 900 N/mm ²	0.15 to 0.20	8.5	15	29	67
	Grey cast iron R_m \sim 150 to 450 N/mm ²	0.11 to 0.25	10	17	21	47
	Aluminium alloy, non heat treated	0.22 to 0.40	17	29	36	87
	Aluminium alloy, heat treated	0.19 to 0.35	14	25	33	76
			\sim Preload force F_M [kN] ¹⁾			
			7	9.9	18.1	28.8

¹⁾ Standard values with bare connecting elements for achievable preloads F_M [kN] for steel counter-layer with tensile strength < 800 N/mm².

Checking the vibration resistance based on DIN 65151

Two plates braced against each other with a screw are subjected to a forced vibration (relative movement). Unsecured screws completely loosen within a short period of time.

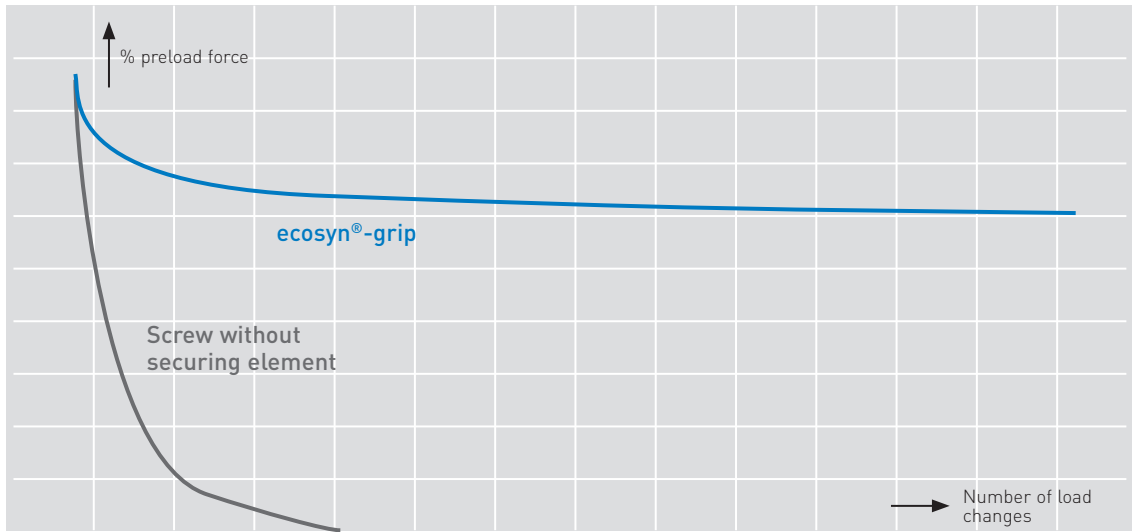

Loss of preload force in the vibration test

Lean design, full load-bearing capacity

Screws with an internal drive and small head height often have the disadvantage that the material recess for the drive leads to a weakening of the screw head. High torsional loads, such as very strong tightening, can therefore lead to a screw failure.

ecosyn®-grip combines the appealing design of an ISO 7380-2 screw with the load-bearing capacity of an 8.8 screw, such as ISO 14579.

The screw is fully load-bearing and can thus also transmit even large operating forces, which is a significant advantage compared to screws with a low head.



Product range overview

Hexalobular socket pan head screws with serrated flange, ecosyn®-grip SF

BN 219 steel 8.8, galvanized, thick-layer passivated.

d_1	M5	M6	M8	M10	d_1	M5	M6	M8	M10
$d_{2\max}$	11.5	14.5	19	22.3	10	•	•		
k_{\max}	4.2	4.9	6.5	8	12	•	•	•	
☉	X25	X30	X45	X50	16	•	•	•	•
t_{\max}	2.03	2.42	3.31	4.02	L 20	•	•	•	•
A	4.5	5.6	7.95	8.95	25		•	•	•
					30			•	•
					35				•

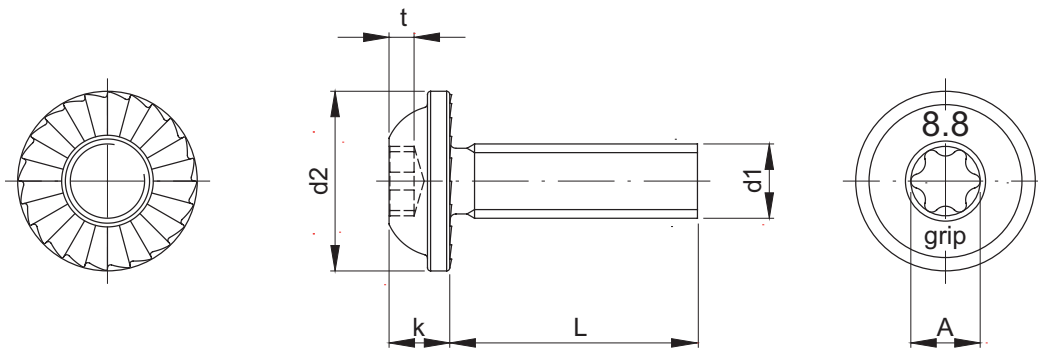

ecosyn®-grip SF: Hexalobular socket pan head screw with serrated flange and full thread

Areas of application

ecosyn®-grip screws are in particular suitable for screw connections in sheet metal with increased requirements for safeguards against loosening or vibration. Some examples:

- Car body construction
- Interior lining
- Covers
- System construction
- Vehicle trim
- Sheet metal constructions
- Domestic installations
- Profile connections
- Cabinet construction
- Transport system construction
- Guide rails

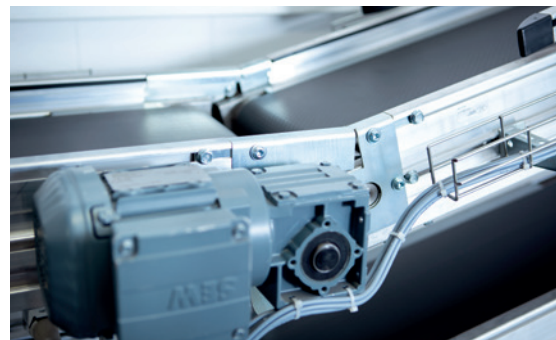

ecosyn®-grip screws in a conveyor belt

PROVEN PRODUCTIVITY – A PROMISE TO OUR CUSTOMERS

The strategy for success

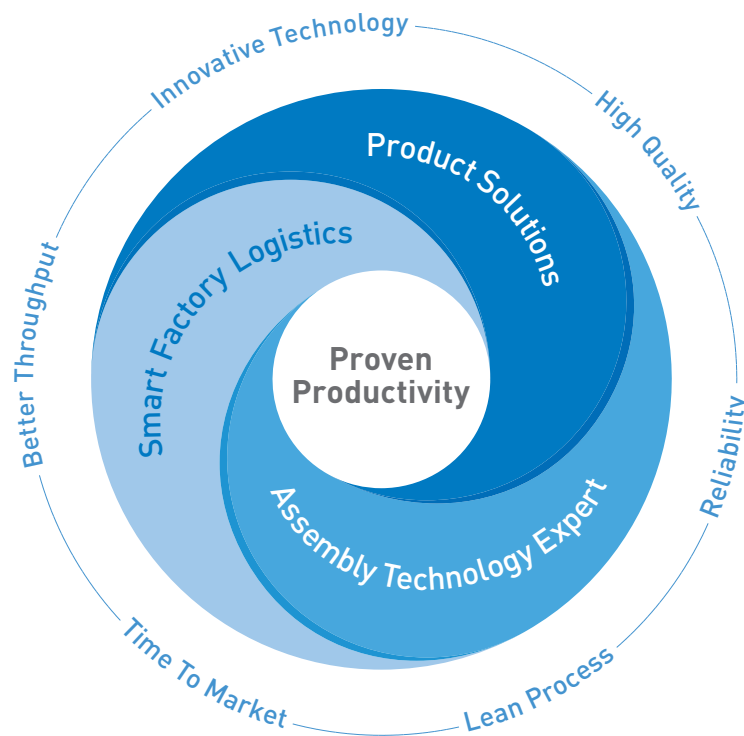

From years of cooperation with our customers we know what achieves proven and sustainable impact. We have identified what it takes to strengthen the competitiveness of our customers. Therefore we support our customers in three strategic core areas.

Firstly, when finding optimal **Product Solutions**, that is in the evaluation and use of the best fastening part for the particular function intended in our customers' products.

Second, our **Assembly Technology Expert** services deliver the smartest solutions for all possible fastening challenges. Our services cover from the moment our customers developing a new product, to

assembly process optimization as well as fastening technology education for our customers' employees.

And thirdly, optimising our clients' productions in a smart and lean way with **Smart Factory Logistics**, our methodology, with intelligent logistics systems and tailor-made solutions.

Understood as a promise to our customers, "Proven Productivity" contains two elements: Firstly, that it demonstrably works. And secondly, that it sustainably and measurably improves the productivity and competitiveness of our customers.

And this for us is a philosophy which motivates us every day to always be one step ahead.

www.bossard.com