



Operating instructions

Battery-Blind-Riveting-Tool RTB-20(-S)

NOTE

In case of doubt, the original German version of the operating instructions applies.

Table of contents

PAGE	4	1 Operating principles	
		1.1	Scope of delivery 4
		1.2	General information 4
		1.3	Signs and symbols used 6
		1.4	Structure of the warnings 7
		1.5	Technical terms and abbreviations used 7
		1.6	Intended use 8
		1.7	Improper use 8
		1.8	Duties of the operator 9
		1.9	Duties of personnel 9
		1.10	Training of personnel 10
		1.11	Guarantee and liability 10
		1.12	Copyright 11
PAGE	12	2 General safety information for power tools	
		2.1	Occupational safety 12
		2.2	Electrical safety 13
		2.3	Safety of people 13
		2.4	Use and handling of power tools 14
		2.5	Use and handling of battery tools 15
		2.6	Service 16
PAGE	17	3 Important information about this tool	
		3.1	Handling the associated lithium ion battery 17
		3.2	Information on the associated charger 18
		3.3	Structural modifications 18
		3.4	Cleaning the device and disposal 19
PAGE	20	4 Start-up and use	
		4.1	Tool structure 21
		4.2	Operation 22
		4.2.1	Inserting and removing the battery 22
		4.2.2	Press start button 23
		4.2.3	Front LED 23
		4.2.4	LED indicator at the back and sound signals 24
		4.2.5	OLED display 24
		4.2.6	Empty remaining collection container 25
		4.2.7	Reducing pipes 27
		4.2.8	Selection of nose piece 27
		4.2.9	Selection of nose assembly 28
		4.2.10	Set fastener 29
		4.2.11	Contact pressure sensor 30
		4.2.12	QuickRiv-Technology 31
		4.2.13	Overload 32
		4.2.14	Standby and Shut-down mode 32

4.2.15	Charge state of the battery	33
4.3	Display	34
4.3.1	Display notifications	35
4.4	Bossard SmartTool-Manager	40
4.4.1	Setup	43
4.4.2	General → Process control	43
4.4.3	General → Energy & Lighting	45
4.4.4	General → Features	46
4.4.5	General → TM version	47
4.4.6	Management	48
4.4.7	Signals → OLED-display	49
4.4.8	Signals → LED	50
4.4.9	Signals → Sound signals	51
4.4.10	Signals → Vibration alarm	52
4.4.11	Graphics	53
4.4.12	System time	54
4.4.13	Basic settings	55
4.4.14	Update	56
4.4.15	Programming	57
4.4.16	Program	57
4.4.17	Program → Option	64
4.5	Maintenance and service	66
4.6	Cleaning	66
4.6.1	General information	66
4.6.2	Clean clamping jaws	67
4.6.3	Service interval counter	68

PAGE **69** **5 Storage**

PAGE **70** **6 Technical data**

PAGE **72** **7 Troubleshooting and Fault repair**

PAGE **73** **CE Declaration of conformity**

1 Operating principles

Dear customers,

thank you for choosing a Bossard SmartTool product.

This quality product „Made in Germany“ fulfils the highest requirements with regard to performance, quality and accuracy. When used correctly the product will undoubtedly perform very well for many years.

These operating instructions contain information on safety and for the operation of the tool. In addition it contains information on the dimensions and technical data. We would be happy to assist you with additional information or to answer your questions. Our technical support and our technicians would be happy to assist you.

1.1 Scope of delivery

- Battery-Blind-Riveting-Tool
- USB Cable (Type A on Mini B)
- Operating instructions
- Machine capability test (MCT)

1.2 General information

Read the tool operating instructions before initial operation. **Please pay particular attention to Chapter 2 „General Safety Notes“.**

This operating instruction should make it easier for the operator to get to know the tool and to use it for its intended purpose. The operating instructions include important information related to the safe and proper operation of the tool. Compliance with these instructions helps you to:

- Avoid hazards
- Avoid repair costs and downtimes
- Increase the reliability and the lifespan of the product.

This operating instructions must be read and applied by every person who is assigned to conduct work using this tool.

In addition to this operating instructions the applicable regulations on accident prevention and environmental protection should be observed.

















NOTE

After reading, keep the operating instructions in a place accessible to every operator. If you have any further questions, please feel free to contact us.

1.3 Signs and symbols used

The following signs and symbols will be used in this operating instructions or on the product:

Symbol	Explanation
	Read this operating instructions
	Do not dispose with household waste
	Do not dispose the battery in a fire
	Do not throw the battery into water
	EU conformity marking
	Registered trademark
	Use only indoors
	Protection class II
	Intrinsically safe transformer
	Battery is charging
	Defective battery
	Battery fully charged
	Direct current
	Universal Recycling Symbol

1.4 Structure of the warnings

The warnings are structured as follows:



DANGER

Indicates an immediate dangerous situation that can lead to serious or even deadly injuries and/or that could seriously damage or even destroy the tool.



WARNING

Indicates a potentially dangerous situation that can lead to serious injuries and/or damage to the tool.



NOTE

Important and useful information on using this tool.

1.5 Technical terms and abbreviations used

Abbreviation	Meaning
°C	Degrees Celsius, temperature
AC	Alternate current
Ah	Amp hours, electric charge, battery capacity
a_{hv}	Overall vibration
dB(A)	Decibels, sound pressure level (A-weighted)
DC	Direct current
Hz	Hertz, Frequency
Li-Ion	Lithium-ion, battery technology
L_{pA}	Emission sound pressure level, workplace-related
m/s^2	Acceleration, Vibration

Abbreviation	Meaning
min ⁻¹	Revolutions per minute, Speed
mNN	Meters above sea level, height
SN	Serial number
V	Volts, electrical voltage
W	Watts, electrical power

1.6 Intended use

This battery operated blind riveting tool was designed to prepare rivet joints. The tool may only be used for this purpose as described in this operating instructions. Only materials that are suitable for this type of tool may be used.



WARNING

Intended use also includes

- following all indications of the operating instructions and
- observance of inspection and maintenance works.

Any other use or use beyond that is considered improper use. Neither HS-Technik GmbH as manufacturer nor Bossard AG as sales partner are liable for any resulting damage.

1.7 Improper use



DANGER

The use of this tool for other purposes, e.g. for hammering, is not permitted. Improper use or incorrect accessories can lead to dangers with unforeseeable consequences.

We accept no liability for damage and malfunctions resulting from non-observance of these operating instructions and improper use.

1.8 Duties of the operator

The operator undertakes to only allow people who are familiar with the basic regulations on occupational safety and accident prevention and who have been trained on how to use the tool at the workplace to work with this tool.

The safety awareness of the personnel while working has to be reviewed at regular intervals.

In addition it is necessary to established safety measures for operator safety which are based upon an estimation of the vibration load during actual conditions of use.

1.9 Duties of personnel

Prior to its use all people who work with this tool are obligated to inform themselves of the applicable workplace safety and accident prevention regulations for this power tool and to observe them.

It is recommended that every operator wears hearing protection.

1.10 Training of personnel

Only trained and instructed personnel should work with this tool. The responsibilities of the personnel must be clearly defined. Trainees may only work with this power tool under the supervision of an experienced person.

1.11 Guarantee and liability

Guarantee and liability claims for personal injury and property damage are excluded, if caused by one or more of the following:

- improper use
- failure to observe these operating instructions
- improper installation, commissioning, operation and maintenance of the device
- Operating the device with defective safety devices or improperly installed, or non-functioning safety and protective devices
- Failure to observe the information in the operating instructions regarding transport, storage, assembly, commissioning, operation and maintenance of the device
- unauthorised structural modifications to the device
- improperly performed repairs
- catastrophes due to external influences and acts of God

1.12 Copyright

These operating instructions are intended solely for the operator and its personnel.

They contain guidelines and information which may not be fully, or partially

- reproduced
- distributed or
- otherwise shared.

The copyright of these operating instructions is retained by
HS-Technik GmbH / Bossard AG.

Address of the manufacturer:

HS-Technik GmbH
High - System - Technik

HS-Technik GmbH
Im Martelacker 12
D-79588 Efringen-Kirchen

Phone: +49 (0)7628 - 91 11-0
Telefax: +49 (0)7628 - 91 11-90
E-Mail: info@hs-technik.com
Internet: www.hs-technik.com

Address of the distributor:

BOSSARD
Proven Productivity

Bossard AG
Steinhauserstrasse 70
CH-6301 Zug

Phone: +41 41 749 6611
Telefax: +41 41 749 6622
E-Mail: bossard@bossard.com
Internet: www.bossard.com

2 General safety information for power tools



DANGER

Read all the safety information, instructions, illustrations and technical data which is provided with this power tool. Failure to follow the instructions below may result in electric shock, fire and/or serious injury.



WARNING

This power tool was manufactured in accordance with current state-of-the-art technology and recognised technological safety guidelines. However, its use may jeopardise the health and life of the user or third parties, or risk damage to other property.



WARNING

The workplace must only be used in accordance with its intended use and in absolutely perfect condition.



NOTE

Keep all safety information and instructions for the future.



NOTE

Only have your device repaired by qualified professional staff and only with original replacement parts which are available at Bossard. This ensures that the safety of the device is maintained.

The term „power tool” used in the safety information refers to mains-operated power tools (with mains cable) and to battery-operated power tools (without mains cable).

2.1 Occupational safety

- a) **Keep your work area clean and well-lit.** Cluttered or dark work areas can lead to accidents.
- b) **Do not work with the power tool in an explosive environment in which there are flammable liquids, gases or dust.** Power tools generate sparks that can ignite the dust or fumes.
- c) **Keep children and other people away while using the power tool.** You can lose control of the power tool if you are distracted.

2.2 Electrical safety

- a) **Avoid body contact with grounded surfaces such as pipes, heaters, stoves and refrigerators.** There is an increased risk of electric shock if your body is grounded.
- b) **Keep power tools away from rain or moisture.** Penetration of water into a power tool increases the risk of electric shock.
- c) **Do not misuse the connection cable in order to carry, or hang up the charger, or to pull the plug out of the socket. Keep the connection cable away from heat, oil, sharp edges or moving parts.** Damaged or tangled connection cables increase the risk of electric shock.
- d) **If operating the charger in a damp environment cannot be avoided, use a fault-current circuit breaker.** The use of a fault-current circuit breaker reduces the risk of electric shock.
- e) **Check the electrical equipment regularly. Immediately remove loose connections and scorched cables.** Loose connections or scorched cables can lead to electric shock and risk of fire.

2.3 Safety of people

- a) **Be alert, pay attention to what you are doing and take care when you are working with a power tool. Do not use a power tool when you are tired or under the influence of drugs, alcohol or medication.** A moment of inattention while using the power tool can result in serious injury.
- b) **Wear personal protective equipment and always safety glasses.** Wearing personal protective equipment such as a dust mask, non-slip safety shoes, safety helmet or hearing protection, depending on the type and use of the power tool lowers the risk of injury.
- c) **Prevent accidental starting. Ensure that the power tool is switched off before you connect it to the power supply and/or the battery, pick it up or carry it.** Accidents can occur if you have your finger on the switch while carrying the power tool or if you connect the power tool to the power supply when it is switched on.
- d) **Avoid abnormal postures. Make sure you have a secure footing and keep your balance at all times.** This gives you better control of the power tool in unexpected situations.

- e) **Wear suitable clothing. Do not wear loose clothing or jewellery. Keep hair and clothing away from moving parts.** Loose clothing, jewellery or long hair can get caught in moving parts.
- f) **Do not lull yourself into a false sense of security and do not disregard the safety rules for power tools, even if you are familiar with the power tool after repeated use.** Careless action can lead to serious injuries within a split second.
- g) **Actively avoid accidentally switching on the power tool. If the tool is to be in idle mode for a long time, remove the battery beforehand.** This prevents unintentional start-up.

2.4 Use and handling of power tools

- a) **Do not overload the power tool. Use the power tool specific for the work you are doing.** With the appropriate power tool you will work better and more safely in the power range indicated.
- b) **Do not use any power tool which has a defective switch.** A power tool which can no longer be switched on or off is dangerous and must be repaired.
- c) **Remove the detachable battery before you make changes to device settings, change application tool parts or put away the power tool.** This precaution prevents unintentional start up of the power tool.
- d) **Keep unused power tools out of the reach of children. Do not let anyone use the power tool who is not familiar with it or has not read this operating instructions.** Power tools are dangerous when used by inexperienced people.
- e) **Maintain power tools and the application tool with care. Check whether moving parts function properly and do not jam, whether parts are broken or damaged in such a way that the function of the power tool is affected. Have damaged parts repaired before using the power tool.** Many accidents are caused by poorly serviced power tools.
- f) **Keep the tool sharp and clean.** Carefully maintained tools jam less often and are easier to manage.
- g) **Use power tools, application tools, etc. in accordance with these instructions. While doing so observe the work conditions and the activities to be performed.** The use of power tools for anything other than the intended application can lead to dangerous situations.

- h) **Keep handles and gripping surfaces dry, clean and free of oil and grease.** Slippery handles and gripping surfaces do not allow safe operation and control of the power tool in unforeseen situations.
- i) **Use the correct power tool.** Do not use under-performing tools for heavy loads. Do not use tools for purposes and work for which they are not intended.
- j) **Check your device for damage.** Before continued use of the tool safety equipment must be tested for proper and intended function. Check whether the function of moving parts is okay, whether they do not jam, whether any parts are broken, whether all other parts function properly and whether all conditions which must be met for the proper operation of the device have been met. Damaged protective devices and parts should be properly repaired, or replaced by trained customer service unless otherwise specified in this operating instructions. Damaged switches must be replaced by a customer service workshop. Do not use any tools which cannot be properly switched on and off using the start button.

2.5 Use and handling of battery tools

- a) **Charge the battery only with charging devices which are recommended by the manufacturer.** There is a risk of fire if the battery is used on an unsuitable charger and the battery can be permanently damaged.
- b) **Use only the specifically designated battery for the power tool.** The use of other batteries can lead to injuries and the risk of fire.
- c) **Keep the unused battery away from paper clips, coins, keys, nails, screws or other small metal parts which could cause a bypass of the contacts. Do not open the battery and do not short circuit.** A short circuit between the battery contacts can lead to burns or fire.
- d) **Fluid can leak out of the battery in the event of incorrect use. Avoid contact with it. In the event of accidental contact with skin rinse with water. If the fluid comes into contact with the eye seek medical help.** Leaking battery fluid can lead to skin irritations or burns.
- e) **Do not use damaged or altered batteries.** Damaged or altered batteries can behave unpredictably and can lead to fire, explosion or injury.
- f) **Do not expose a battery to fire or high temperatures.** Fire or temperatures above 130°C can cause an explosion.

- g) **Follow all instructions for charging and never charge the battery or the battery tool outside of the temperature range specified in the operating instructions.** Incorrect charging or charging outside of the approved temperature range can damage the battery and increase the risk of fire.

2.6 Service

- a) **Only have your power tool repaired by qualified professional staff and only with original replacement parts which can be available at HS Technik GmbH.** This ensures that the safety of the power tool is maintained.
- b) **Never perform maintenance on damaged batteries.** All maintenance of batteries may only be completed by the manufacturer or authorised customer service locations.

3 Important information about this tool

3.1 Handling the associated lithium ion battery

- a) **Observe the operating instructions of the Li-Ion battery.**
- b) **If the battery will not be used over a longer period of time it may not remain on the charger or on the machine.** If an interruption of work of more than 3 hours is expected the battery must be removed from the tool. Otherwise it cannot be excluded that the battery will be permanently damaged.
- c) **For safety reasons the Li-Ion battery should not remain on the activated charger for longer than 36 hours.** Remove the battery from the charger as soon as possible after charging is complete.
- d) **An empty battery should not be in contact with the machine or a charger disconnected from the mains for a longer period of time.** In both instances low currents flow which totally discharge the battery and can permanently damage it.
- e) **Always charge the Li-Ion battery as soon as possible after use and do not store it when empty.** If the battery is stored separately from the tool and the charger its capacity will remain constant for a long period of time (loss approx. 5% per year).
- f) **Always transport the battery separately from the machine if possible.** This prevents accidental switching on of the machine as well as a total discharge of the battery.
- g) **Do not subject the Lithium-Ion battery to high temperatures (above 50°C) or direct sunlight.** If the battery gets warmer than 50°C during operation (charging or discharging) it must be immediately separated from the charger or the tool.
- h) **Under extreme use or temperature conditions batteries may leak. In the event of a leaky battery avoid contact with the skin or eyes.** The battery fluid is corrosive and can cause chemical burns to tissue. If the fluid comes into contact with the skin it must be washed immediately with soap and water and then rinsed with lemon juice or vinegar. If the fluid comes into contact with the eyes they must be rinsed for at least 10 minutes with water and a doctor must be consulted immediately.
- i) **Ensure that the Li-Ion battery does not fall or is not subjected to vibrations or shocks.**
- j) **Clean the battery contacts regularly with a cotton swab dipped in high-proof alcohol.**



NOTE

Lithium-Ion batteries have almost no self-discharge and have no memory effect. With proper and professional handling your tool will be reliably supplied with high energy density for a long period of time.

3.2 Information on the associated charger

- a) **Observe the operating instructions of the charger.**
- b) **The charger may not be connected to a step-up converter, generator or a direct current outlet.**
- c) **Ensure that the ventilation slots on the charger are not covered or blocked.**
- d) **Never charge the battery inside a carton or a closed container. They battery may only be charged in a well ventilated location.**
- e) **Do not charge the battery at temperatures BELOW 10°C or ABOVE 40°C.**
- f) **Do not store the power tool, the charger and the battery in locations in which temperatures are above 50°C. In particular, avoid direct sunlight.**

3.3 Structural modifications

No changes, additions or conversions to the power tool may be made without the approval of the manufacturer.

All conversion measures require written consent and confirmation by the manufacturer.



WARNING

In the event of the replacement of wear and tear parts only original replacement parts may be used.

3.4 Cleaning the device and disposal

Substances and materials used must be handled and disposed of properly, particularly when cleaning with solvents.

Do not throw the used battery into the household waste, fire or water, instead have it professional disposed of by a specialist or the manufacturer.



4 Start-up and use

DANGER

Risk of injury from damaged tools

Damaged tools can lead to injuries or damages.

- All damaged parts must be repaired before use.

Risk of injury from falling tools

Falling tools can lead to injuries or damages.

- Ensure you are self-belayed and have a secure footing.
- Avoid dropping the tool.



Risk of burns due to hot exhaust air

Hot air can escape through exhaust openings.

- Do not place any sensitive body parts directly in front of exhaust openings.

Risk of injury due to improper use

Improper use can lead to injuries or damage.

- Use the tool only for the intended purposes.

Risk of injury from substances

Substances such as lubricating oil and grease are flammable on the skin.

- Avoid contact with such substances.
- Should you still come into contact wash the affected area carefully.



NOTE

Maintain your tool with care. Follow the operating instructions during maintenance and cleaning. Keep the handle free of lubricants and dirt.



NOTE

Do not drop the tool, and do not let any other objects fall onto the tool. Protect it from impacts.



NOTE

Ensure that the tool does not come into contact with splashing water or oil.

4.1 Tool structure

1. Start button
2. Traction head with nose piece*
3. Riveting mandrel container
4. Multi-colour LED
5. 18 V Li-ion battery*
6. OLED Display
7. LED for work area lighting



* Battery, nose piece and threaded mandrel are not included in the standard scope of delivery and must be ordered separately.

4.2 Operation

4.2.1 Inserting and removing the battery

- In order to insert the battery (1), align it so that it can be easily pushed onto the mounting provided along the plastic guide. After sliding it on completely, the fastening clip (2) must lock the battery firmly and properly into place in the tool housing.
- In order to remove the battery push the fastening clip on the front side of the battery down and pull the battery forward and off.
- Don't use force to install the battery. If the battery can not be easily pushed on it was not correctly positioned.



NOTE

Always push the battery all the way in until it locks into place with a click.



WARNING

Risk of injury from falling battery

If the battery is not correctly locked it can fall out and cause injuries.

- Always ensure that the battery is fully locked into place.



- 1) Battery
- 2) Fastening clip

4.2.2 Press start button

Pressing or actuating the start button starts or stops the tool.



NOTE

The battery riveting tool only starts when the battery has sufficient capacity.



* Start button

4.2.3 Front LED



WARNING

Risk of injury from the light emitting diode

Looking directly into the light emitting diode can lead to eye injuries.

- Never look directly into the light emitting diode.

The LED on the front of the tool is used to illuminate the assembly area. After pressing the start button, the LED lights up. It turns off automatically after a few seconds. The afterglow time of the LED can be parametrised in the SmartTool-Manager under „setup“ → „general“ → „energy&lighting“.



* Front LED

4.2.4 LED indicator at the back and sound signals

Circumferential indicator lights up green after setting, no sound signal

- The parametrised setting was completed successfully.
- The battery capacity is sufficient, the tool is ready for the next setting.

Circumferential indicator lights red after setting, no sound signal

- A programmed parameter was not reached.



* LED Light indicator



NOTE

The tool will only start after a battery change if the battery has sufficient capacity.

4.2.5 OLED display

- After a sufficiently charged battery has been pushed on the tool will start.
- After pressing the start button, the tool is initialised. The back, circumferential indicator briefly lights up with multiple colours. A beep sounds and on the back of the tool the display indicates the current status.
- The tool is now ready for use.
- After several seconds without actuation the display will dim. After longer downtime the tool will switch into standby mode.

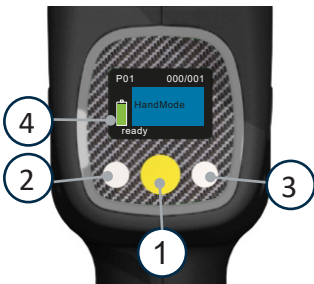

1. Button for menu activation and selection
2. Button for decreasing value (-)
3. Button for increasing value (+)
4. State of charge display

4.2.6 Empty remaining collection container

The riveting mandrel container for the torn off riveting mandrels must be emptied regularly. Turn the container by hand approx. 45° „counter clockwise“ or „clockwise“ in order to loosen it and remove it from the riveting machine.

In order to place the riveting mandrel container back on after emptying align the noses and turn the riveting mandrel container approx. 45° until it locks into place and is flush with the riveting mandrel container mount on the tool.



NOTE

Blockage of the riveting mandrel container must be avoided, otherwise the tool could be damaged.

The tool has a reminder function for emptying the riveting mandrel container. To this end the emptying of the mandrel container can be set with the „Service“ user in the SmartTool-Manager.

In addition a minimum time for emptying can be set. This can prevent an employee from briefly turning the riveting mandrel container back and forth, instead of emptying it.



DANGER

Risk of injury from projecting rivets

Injuries can result if you do not use the original, undamaged riveting mandrel container



- Always use only the original, undamaged riveting mandrel container
- Ensure that the container is correctly installed (fully latched locking mechanism)

In order to prevent use of the tool without a riveting mandrel container the riveting mandrel container is monitored using a sensor. The tool can not be operated without the riveting mandrel container and displays the following error message:



4.2.7 Reducing pipes

We provide suitable reducing pipes for rivets with a mandrel diameter smaller than 4.0 mm. Reducing pipes reduce the diameter of the guide tube through the tool and thereby prevent the remaining rivet mandrel from jamming in the guide tube.

Tool type	Tool guide tube	Reducer Reducing pipe	Item number Reducing pipe
RTB-20x	6.3 mm	2.4 mm	BST-RTB-RP-24
RTB-20x	6.3 mm	3.4 mm	BST-RTB-RP-34
RTB-20x	6.3 mm	4.2 mm	BST-RTB-RP-42

WARNING



Risk of injury due to use of incorrect rivets

Using rivets with the incorrect mandrel diameter can lead to significant damage to the tool and cause injuries

- Do not use a rivet with a mandrel diameter below 4.0 mm without a reducing pipe.

4.2.8 Selection of nose piece

You can use the riveting tool for processing different size rivets. When doing so, note the exact specification of the rivet and adjust the nose piece and reducing pipe, if necessary (chapter 4.2.7 von page 27).

The maximum riveting mandrel diameter is \varnothing 1.5 - 4.5 mm with special traction heads diameters of $>$ 4.5 mm are also possible.

Measure the diameter of the riveting mandrel and select the next largest nose piece. e.g. riveting mandrel diameter 2.7 mm / nose piece **BST-RTB-NP-32** (3.2 mm max. riveting mandrel diameter + reducing pipe **BST-RTB-RP-34**). The minimum mandrel length for standard nose pieces is 30 mm and for security nose pieces 35 mm.

Use a 12 mm and 14 mm wrench size tool for mounting the nose piece.



4.2.9 Selection of nose assembly

Tool type	Fastener	Compatible traction head
BST-RTB-EX-1*	Expander (040 – 060)	
BST-RTB-EX-2*	Expander (070 – 100)	
BST-RTB-HUCK	up to 6,3 mm mandrel diameter	Huck / Arconic / Howmet / Gage Bilt**
BST-RTB-Cherry	up to 6,3 mm mandrel diameter	Cherry Aerospace partially Huck / Arconic / Howmet / Gage Bilt**

* Incl. traction head

** There is no guarantee that all traction heads from the manufacturers named will fit. Contact us for further information.



WARNING

Risk of injury due to incorrect installation

Incorrectly installed traction heads can lead to injuries

- Assemble the traction heads only in accordance with the quick guides

4.2.10 Set fastener

NOTE



Always place the riveting tool at a right angle (90°) to the work surface to be riveted. An oblique placement leads to faulty riveting. Use only appropriate nose pieces for the rivet. An incorrect nose piece can lead to damages in the clamping jaws as well as the nose piece. You can find the size of the bore and the clamping area in the rivet manufacturer's information.



1. Place blind rivet in nose piece.
2. Guide the blind rivet into the hole provided.
3. Press the blind rivet against the component in order to activate the pressure trigger (chapter 4.2.11 on page 30).
4. Start setting process by pressing the start button, hold start button down.
5. The tool will recognise the break (chapter 4.2.12 on page 31) and automatically returns to the starting position.
6. Release start button.
7. Let the broken rivet slide into the riveting mandrel containers by tipping the riveting tool.

4.2.11 Contact pressure sensor

The pressure trigger ensures that the blind rivet can only be processed if the pressure trigger is activated. This prevents accidental triggering and ensures that the parts to be processed are lying next to each other.

The pressure trigger can be deactivated in the SmartTool-Manager as described below.

DANGER

Risk of injury from unavailable / deactivated pressure trigger



Tools without, or with deactivated, pressure trigger can be triggered without being placed on a part; significant risk of injury results from projectile rivets

- The tools may only be used by trained personnel
- Wear safety glasses and gloves
- Guide the rivet into the nose piece only directly before beginning the riveting process

In order to deactivate the pressure trigger read out the tool by using the SmartTool-Manager as described in chapter 4.4.17 on page 40.

- Click „programming“
- Select the program, for example program 1, in which the pressure trigger should be deactivated
- Click „option“
- Remove the check mark next to „Pressure trigger“ (see image)
- Click „write“

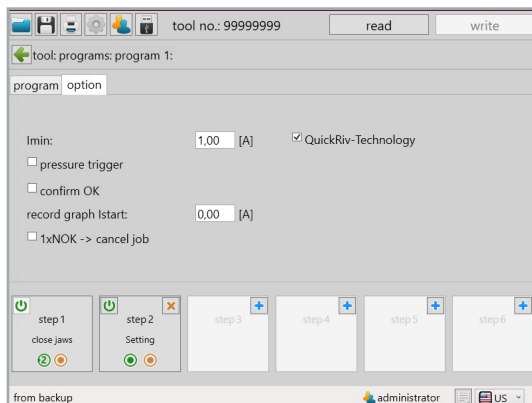

The pressure trigger can not be used in the following tool types due to the system:

- BST-RTB-EX-1
- BST-RTB-EX-2
- BST-RTB-HUCK
- BST-RTB-Cherry

4.2.12 QuickRiv-Technology

The tool has a monitor which automatically recognises when the rivet mandrel breaks and returns the tool back into the starting position. Depending on the traction head or fastener, the break detection must be deactivated. This can be done in the SmartTool-Manager.

In order to deactivate the break detection read out the tool in the SmartTool-Manager as described in chapter 4.4.17 on page 40.

- Click „programming“
- Select the program, for example program 1, in which the pressure trigger should be deactivated
- Click „option“
- Remove the check mark next to „QuickRiv-Technology“ (see image)
- Click „write“

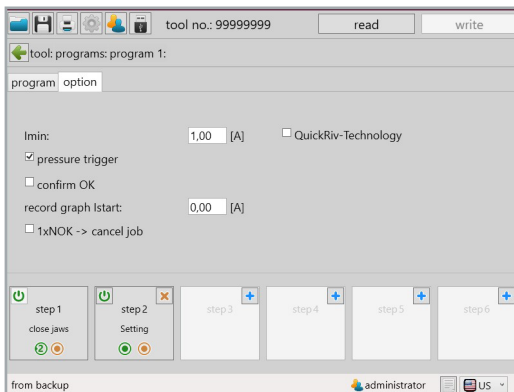

4.2.13 Overload

In order to avoid damages as a result of excess temperatures during continuous operation it is important to observe sufficient break times during the installation process.

If the tool should go into an automatic shut-down (TEMP FET) as a result of excess temperatures the break times should be reviewed and adjusted.



Continued work is only possible after a cooling off period in order to protect the tool from lasting damage.

4.2.14 Standby and Shut-down mode

After approx. 10 minutes without actuation → the tool switches to standby mode
The tool starts up again by briefly tapping on the start button.

After another approx. 30 minutes without actuation → automatic shut-down
Start-up by pressing the start button if the battery has not yet been removed, or right after sliding the battery back on. Both are only possible if the battery has sufficient charge capacity.



NOTE

In the case of longer period of non-use (longer than 3 hours) the battery must be separated from the tool in order to prevent deep discharge of the battery.

4.2.15 Charge state of the battery



NOTE

The tool will only start if the battery has sufficient charge capacity.

When fully charged, the battery will display the charge state on the display on the left side as a green battery symbol. As the battery voltage decreases the colour of the symbol will change to yellow and then red. When it reaches red an additional warning signal will sound, the display will read „warn batt“ and recommend changing the battery. After several additional installations, the tool will no longer start and the display will read „batt low 2“ with a crossed through battery. The battery must then, at the latest, be changed (chapter 4.2.1 on page 22).







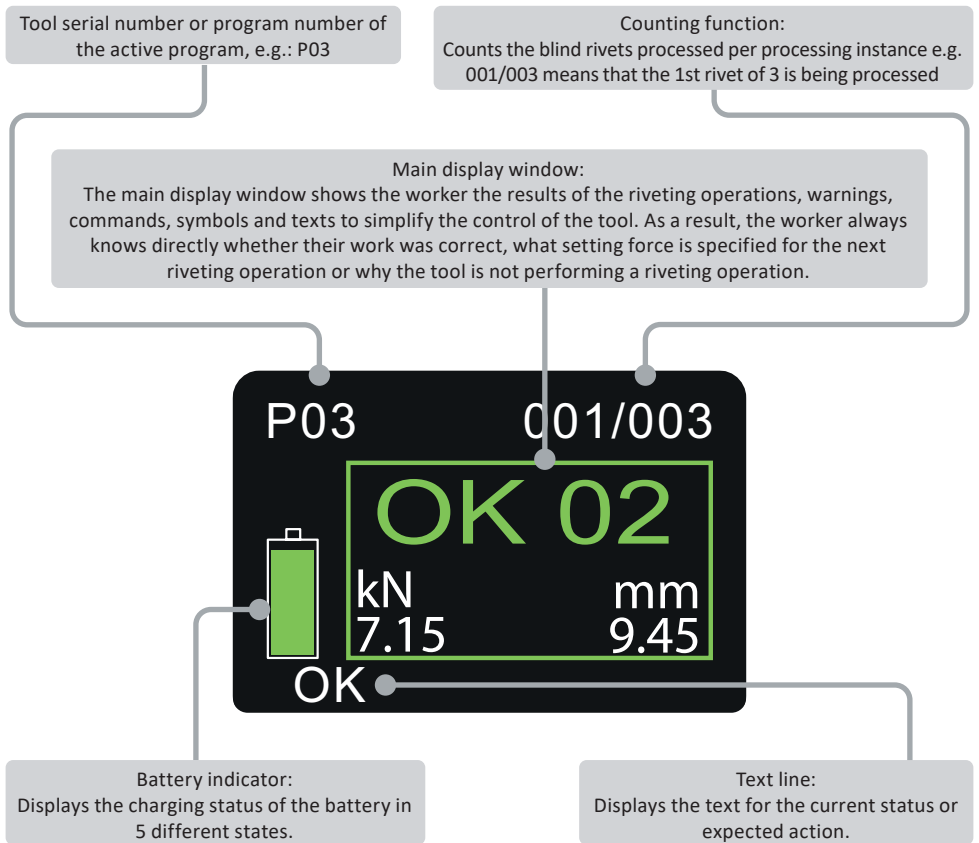

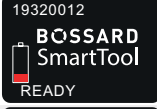

4.3 Display

The displays can be adapted in the SmartTool-Manager so that the worker is shown, for example, exact values for riveting, stroke, only one OK or NOK, or the counting process. The displays can be shown in German or English. You can also set the unit in which the values are output (kN or lbf).

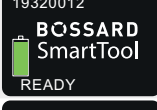

4.3.1 Display notifications

Display notifications	Meaning
	Battery state of charge: 50% - 100%
	Battery state of charges: 30% - 50%
	Battery state of charge: 10% - 30%
	Battery state of charge: 5% - 10%
	Battery state of charge: less than 5%
	The tool is ready for use.
	Tool was started successfully. By briefly pressing the start button, the device moves to its starting position and checks itself for functionality. The device is then ready for operation.
	Product ID must be scanned before the tool is released. Symbol can be represented as a car or an aeroplane.
	Product ID must be scanned before the tool is released. Symbol can be represented as a car or an aeroplane.

Display notifications Meaning



Request for scan:
Component 1, 2 or 3 depending on the number in the building block of the display must be scanned before the tool will be enabled.



Pressure trigger not actuated! To rivet, press the nose piece against the part to be riveted.



Rivet mandrel collector not screwed on or not screwed on correctly.



Pressure trigger still pressed after riveting process when trying to rivet again. First the pressure trigger must be released and actuated again. For locking ring bolts and Huck adapter versions, switch off the pressure trigger in the SmartTool-Manager.

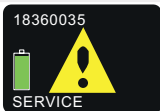

Cleaning interval of the jaws reached. Please clean the jaws and reset the rivet counter in the software.



Product ID must be scanned before the tool is released. Symbol can be represented as an aeroplane or a car.

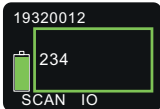

The scan of the barcode with the number "234" was successful.

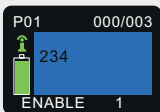

Tool was released for three riveting operations. No barcode was scanned for the release, therefore the serial number is shown in the release field.

SmartTool-Manager display setting:
Display - OLED display - Standard



The tool is not released.

For NOK results, the visualisation area is framed in red and the green result display is also red.

Display notifications Meaning

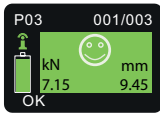

The first of three riveting operations was successful. Achieved force 7.15 kN and a stroke of 9.45 mm. This message is also available as a NOK notice.

SmartTool-Manager display setting:
Display - OLED display - Display of results: Smiley



The first of three riveting operations was successful. Achieved force 7.15 kN and a stroke of 9.45 mm. This message is also available as a NOK notice.

SmartTool-Manager display setting:
Display - OLED display - Display of results: Force

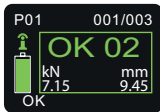

The first of three riveting operations was successful. In the visualisation area, the counter decreases as the remaining number of rivets is displayed. This message is also available as a NOK notice.

SmartTool-Manager display setting:
Display - OLED display - Display of results: Rivet counter

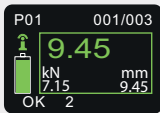

The first of three rivet nuts was successful. Achieved force 7.15 kN and a stroke of 9.45 mm. This message is also available as a NOK notice.

SmartTool-Manager display setting:
Display - OLED display - Display of results: Travel

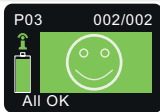

All three riveting operations were successful.

SmartTool-Manager display setting:
Display - OLED display - Display of results: Large smiley



Example of the NOK setting process:

Process 1 NOK, 2 processes left. If NOK acknowledgement is activated, the display must be acknowledged by pressing the yellow display button.



Tool must be calibrated and is only released again after calibration.



Tool must go for servicing and is only released again after confirmation by the service team.



The battery voltage can be displayed in the Setup menu under "Info".

Display notifications Meaning

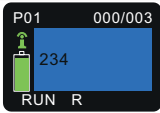

The tool is released for three rivet nuts with program 1. The riveting process is currently in progress. This is indicated by "Running R". "234" corresponds to the ID of the riveting.



Select the scanner to scan the Wi-Fi settings in the Setup menu.
Setup menu settings in the SmartTool-Manager:
General - Functions - Setup menu - Scanner selectable



After selecting the scanner in the Setup menu with the start button, the selection must either be confirmed or discarded with the white display keys.

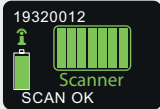

The scanning of the Wi-Fi settings was successful.



Tool is in idle mode. It can be reactivated by pressing the Start button.

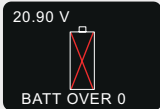

Maximum battery voltage exceeded.



Battery voltage too low.



Tool requires acknowledgement after NOK setting process.

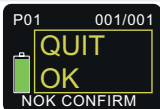

NOK setting process successfully acknowledged.

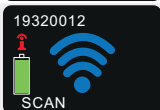

The tool searches for the specified network.

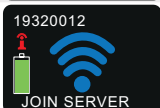

The tool has found the network and connects to it.

Display notifications Meaning



Tool cannot connect to the network.



Maximum temperature of the motor exceeded. Allow the tool to cool down and check break times. If the error persists, contact the manufacturer.



Maximum logic voltage exceeded.
Tools must be repaired!

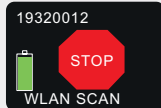

The tool could not find the set network.



Tool is in the wrong IP group.



Maximum permissible force exceeded, contact the manufacturer.



Maximum permissible current exceeded, contact the manufacturer.



If the maximum temperature of the control unit is exceeded, contact the manufacturer.

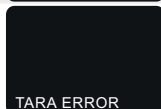

Sensor value error.
Contact manufacturer, tool must be checked.

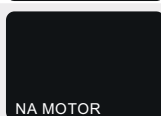

Motor does not start correctly. Motor faulty or incorrect programming. Check the last step of your program in the pulling direction. During this step, Force_{actual} must be activated. Nominal value of the tool must be entered.

4.4 Bossard SmartTool-Manager

This excerpt shows only the most important functions for this tool type. Please find a complete guide and the latest software-version of the SmartTool-Manager on our website: <https://www.bossard.com/smarttool-downloads/>.

NOTE



Always use the most current version of the SmartTool-Manager. The SmartTool-Manager is backward compatible, i.e. it can also read and process older tool versions. If an update of your tool is necessary the SmartTool-Manager will inform you.

1. Start the SmartTool-Manager by double clicking the SmartTool-Manager icon:



SmartTool-Manager

2. Log-in with the required User, a list of the passwords can be requested from your Bossard contact.

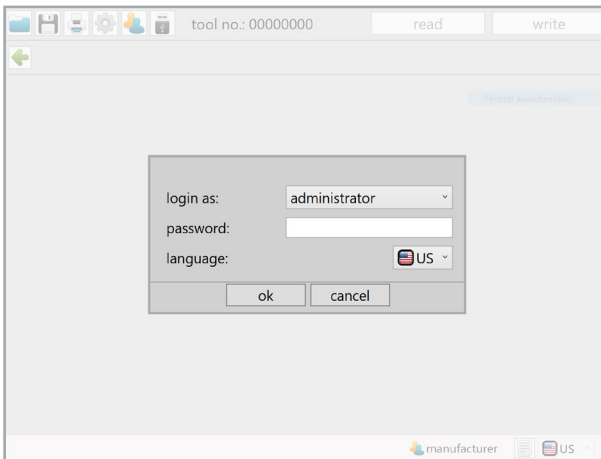

3. Insert the USB cable included into the Mini-B socket at the bottom of the tool and the opposite end into an open USB interface on your laptop / tablet / PC.



4. Click on the „Read“ button on the top right.

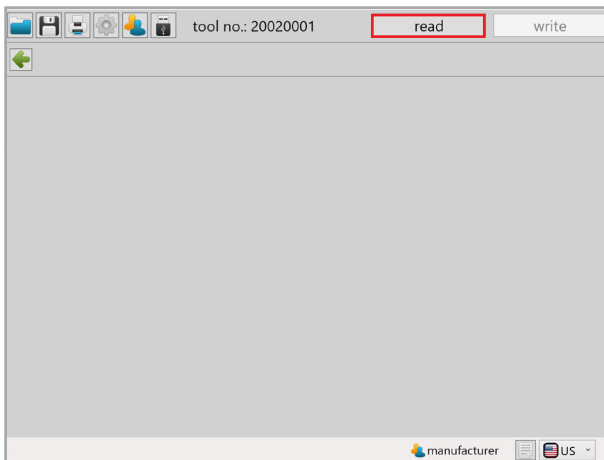

5. The SmartTool-Manager will now read the settings from your tool and will display its progress using a green bar. At the end the tool overview will be displayed.

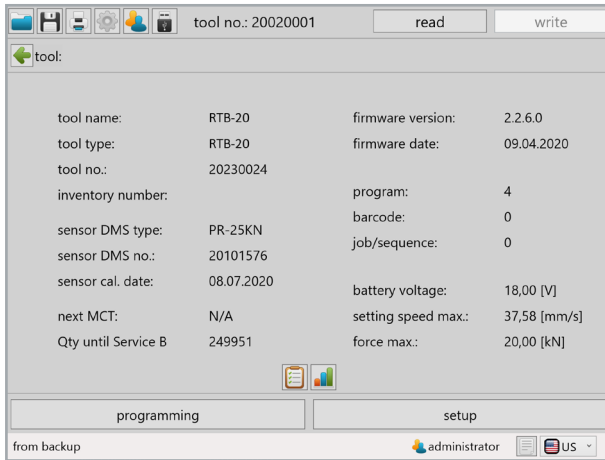

4.4.1 Setup

Clicking on setup takes you to the tool settings menu. Here, for example, the display, LED display, and energy savings settings...can be parametrised.

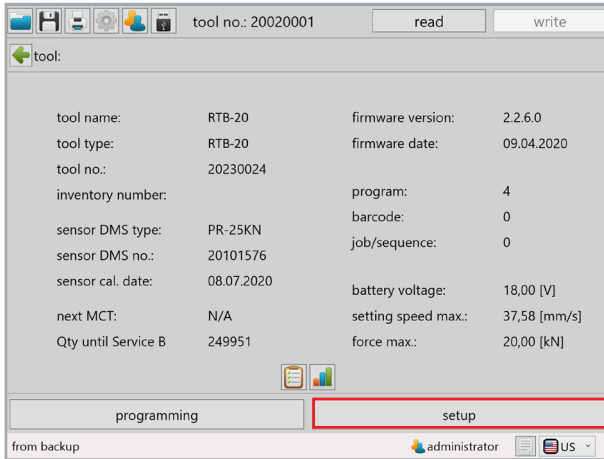

4.4.2 General → Process control

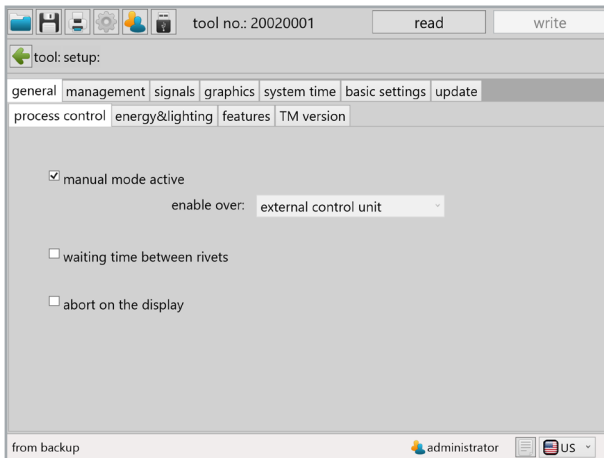

„manual mode active“ If the checkbox is activated, the tool works in manual mode. In other words, the standard program (yellow star) is always executed. In this mode, the counting function, Wi-Fi and barcode are deactivated.

„enable over“

Use the drop-down menu to select how the tool is to be released. To use this function, manual mode must be deactivated.

- „Start button“

The start button must be pressed 3 times in quick succession to release the tool. The tool then works in the standard program with the counter activated.

- „time“

A time must be entered after which the tool is released. The tool then works in the standard program with the counter activated.

- „Start button & time“

A combination of the functions described above. The condition that is reached first releases the tool. The tool then works in the standard program with the counter activated.

- „Barcode“

Activates the barcode scanner in the tool. A barcode must be scanned for release. For more information on programming barcodes, see the HST Tool Manager's operating instructions.

- „Extern control unit“

Activates the Wi-Fi in the tool. The tool is now released by an external controller. Without release, the tool is locked.

- „Barcode & extern control unit“

Activates the barcode scanner and Wi-Fi. The tool scans a barcode which is then sent to the external controller. Based on the scan, the tool is released via Wi-Fi by the external controller.

„waiting time between rivets“ If the function is activated, a time must be entered for the waiting time between two riveting operations. For this time, the tool is without function between the rivets and does not start up.

„abort on the display“ If the function is activated, a time must be entered for the job to be cancelled. The yellow menu key must be pressed for this time to cancel a job.

4.4.3 General → Energy & Lighting

Here you can parametrise the energy saving options and the LED work lighting.

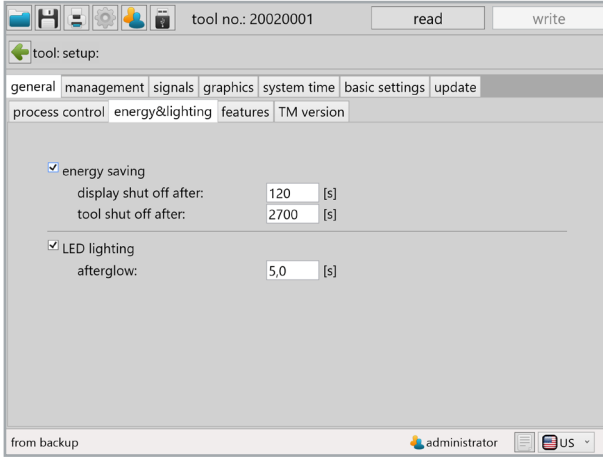

„energy saving“ The energy saving options can be activated or deactivated with the check-box.

„display shut off after“ Time in seconds without action after which the OLED display of the tool will switch off and the screen saver will activate.
Default value: 600 seconds (10 minutes)

„tool shut off after“ Time in seconds without action after which the tool turns off. Default value: 1,800 seconds (30 minutes)

„LED lighting“ The LED lighting can be activated or deactivated with the check-box.

„afterglow“ The amount of time the LED lighting continues to glow after completion of the work process.



NOTE

In systems in which the tool is operated via Wi-Fi, it must be checked whether the functions „Display shut off after“ and „Tool shut off after“ must be deactivated by entering a „0“.

4.4.4 General → Features

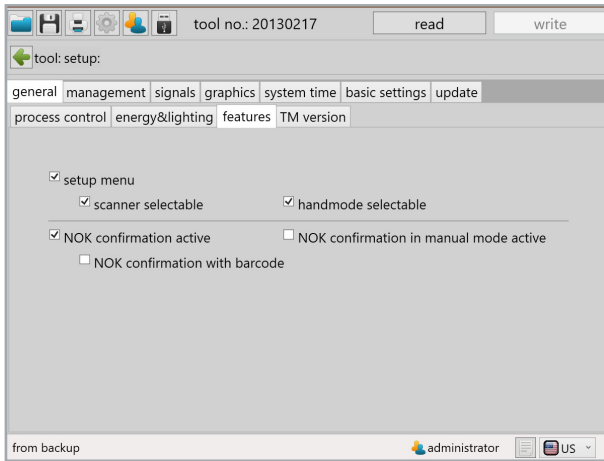

„setup menu“	Activates and deactivates the Setup menu via the display keys. When the function is active, the menu can be accessed by pressing and holding the yellow menu button on the display.
„scanner selectable“	If the function is active, the barcode scanner can be activated and deactivated via the Setup menu on the tool.
„handmode selectable“	If the function is active, you can activate and deactivate manual mode via the Setup menu on the tool.
„NOK confirmation active“	Activates and deactivates the NOK acknowledgement via the yellow menu button.
„NOK confirmation with barcode“	If the function is active, an NOK result can only be acknowledged by scanning a barcode.
„NOK confirmation in manual mode active“	Activates and deactivates the NOK acknowledgement via the yellow menu button when the tool is operated in manual mode.

4.4.5 General → TM version

The TM tab will display the SmartTool-Manager version required for this tool, at minimum, the version intended for the application, and the version last written on the tool.

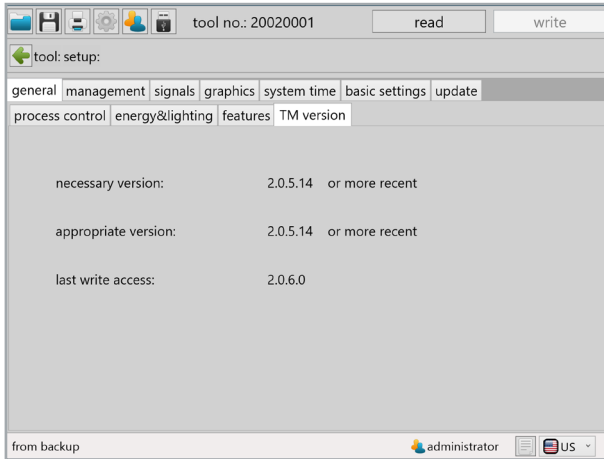

4.4.6 Management

The data on the operating site and the inventory number of the tool can be saved under management.

Location max. 20 characters

Inventory number max. 40 characters

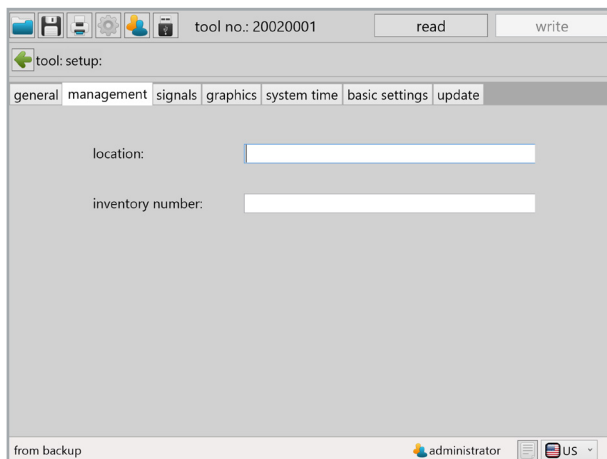

The screenshot shows a software window titled "tool no.: 20020001" with "read" and "write" buttons. Below the title bar is a navigation menu with tabs: "general", "management", "signals", "graphics", "system time", "basic settings", and "update". The "management" tab is selected. The main area contains two input fields: "location:" and "inventory number:". The status bar at the bottom shows "from backup", the user "administrator", and a language dropdown set to "US".

4.4.7 Signals → OLED-display

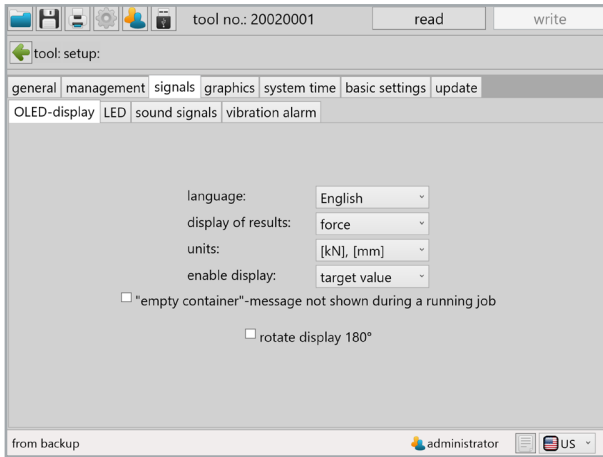

„language“

Select the language on the OLED display, German or English
Default: English

„display of results“

Selection of the result display on the OLED display. **Smiley** shows the result as a smiley with the process values shown small, **Force** shows the achieved force value large, **Travel** shows the achieved travel value large, **Large smiley** shows the result as a smiley without process values.
Default: Large smiley

„units“

Selection of units on the OLED display, SI units or imperial units
Default: SI units (kN and mm)

„enable display“

Selection of the display on the OLED display upon release.
Target value shows the tool's target value, e.g. 10 kN.
Barcode shows the scanned barcode, max. 9 characters.
Default: Set value

„empty container“
Suppress message in favour
of the result display

The message that the container must be emptied is suppressed for the time being so that the result display is not affected. The message is not output until the next release.

„rotate display 180°“

Selecting the check-box turns the display on the OLED display by 180°.

4.4.8 Signals → LED

The LEDs around the OLED display can be parametrised under the LED tab. The colour of the LEDs can be changed by clicking on the coloured square.

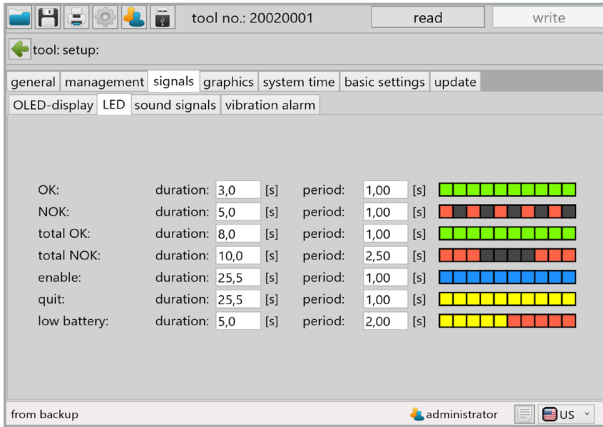

„duration“

The duration of the display in seconds, max. 25.5 seconds.

„period“

The duration of the sequence of the 10 parametrisable indicator fields. Period 1.00 seconds means that the 10 fields will be shown one after another within 1.00 seconds.

4.4.9 Signals → Sound signals

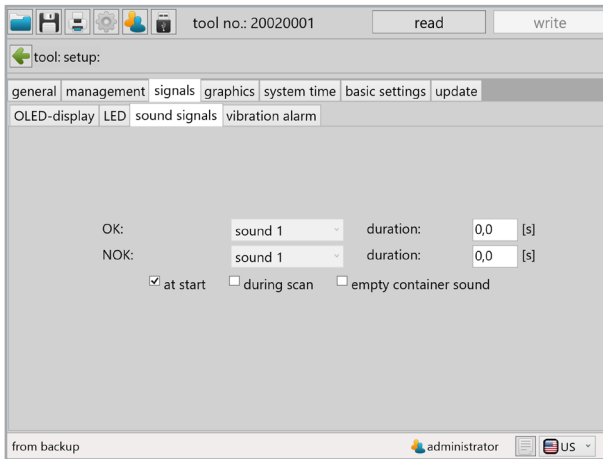

„duration“

The duration is used to parametrise the time of the acoustic signal tone for OK and NOK results in seconds, max. value 3.0 seconds.

„at start“

When the check-box is selected a signal will sound when the tool starts.

„during scan“

If the checkbox is selected, a beep sounds when a barcode is successfully scanned.

„empty container sound“

If this check-box is selected a sound signal will sound in addition to the display notification when the riveting mandrel container needs to be emptied.

4.4.10 Signals → Vibration alarm

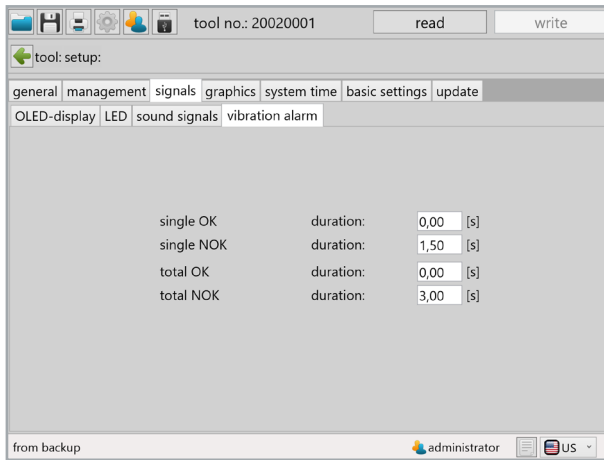

„duration“

The time entry defines how long the vibration alarm is active for. Default for NOK events, „Single NOK“ 2.00 seconds and „Total NOK“ 3.50 seconds.

4.4.11 Graphics

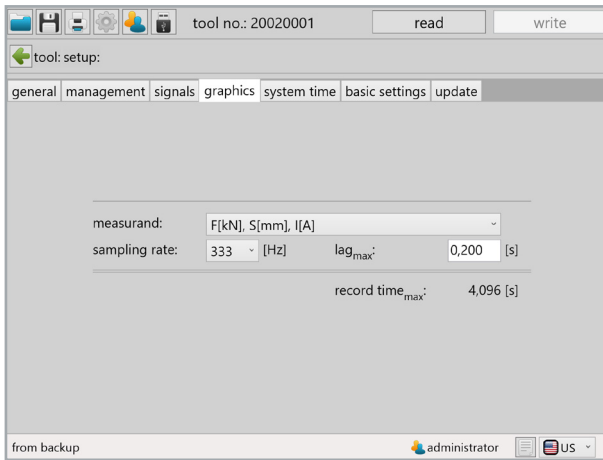

The „Graphics“ tab is used to define what is to be recorded and at what sampling rate.

„measurand“

F[kN] = Force in kN or Lbf
S [mm] = Travel in mm or inches
I [A] = Current in amperes
U [V] = Voltage in volts

„sampling rate“

Defines the default sampling rate at which the curve is recorded; default 333 Hz.

„lag_{max}“

Defines the time for which graphic recording continues after the target criterion has been reached.
Recommended max. value 0.250 seconds, default: 0.150 seconds

„record time_{max}“

Shows how many seconds can be recorded per setting for the selected criteria.
If the recording time is not sufficient, the beginning of the recording is discarded.

4.4.12 System time

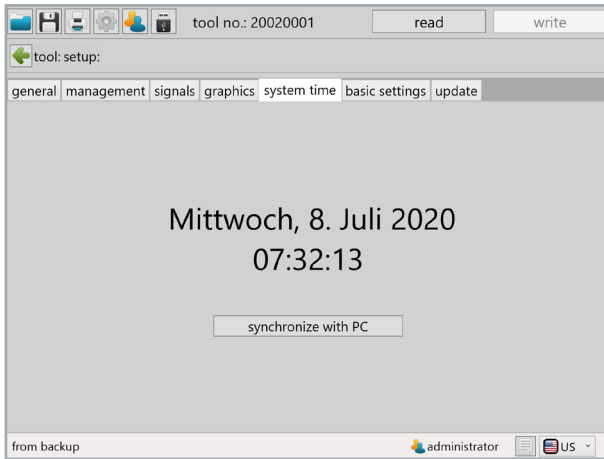

Under System time, the tool's Real Time Clock (RTC) can be synchronised with the time of the PC.

The RTC continues to be supplied with power internally via a capacitor even when the battery is disconnected from the tool. The internal memory for the RTC can be charged via USB as well as via the battery. The internal memory is fully charged after about 30 minutes. To ensure that the tool's time stamp is correct, the internal memory for the RTC must be completely reloaded after 2 weeks at the latest.

If there is a difference of more than 30 seconds between the system time and the time on the tool, a message will appear when the tool is read out.

4.4.13 Basic settings

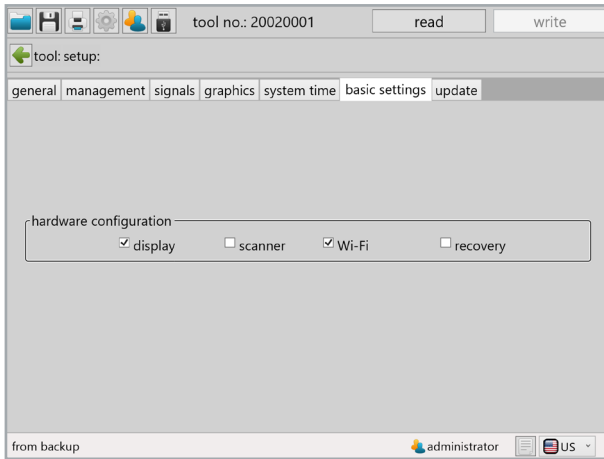

Accessories such as Wi-Fi and the barcode scanner as well as the recovery function can be activated under „Basic settings“.

Wi-Fi and the scanner are automatically activated when these functions are selected in „General → Process control → Release via“.

„display“	Activates and deactivates the OLED display.
„scanner“	Activates and deactivates the barcode scanner. The prerequisite is that the tool is equipped with a barcode scanner.
„Wi-Fi“	Activates and deactivates the Wi-Fi module. The prerequisite is that the tool is equipped with Wi-Fi.
„recovery“	Activates and deactivates the recovery function. This function saves the current rivet counter in the event of a battery change and prompts the employee to work off the remaining quantity of the rivet counter after the battery change. When operating the tool in Wi-Fi systems, the recovery function should be switched off. Default: Deactivated

4.4.14 Update

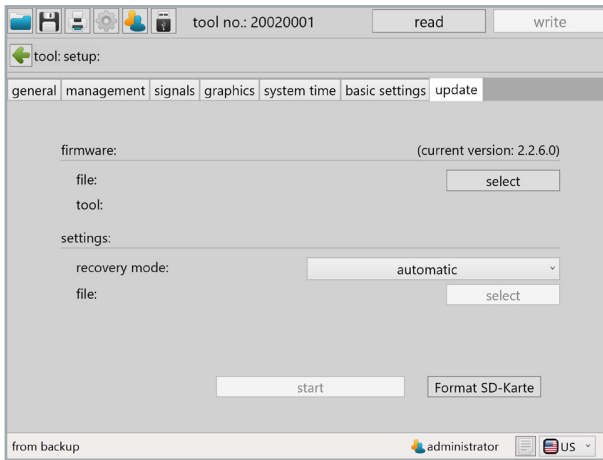

Select

Click on select and find the .upd file. Please select automatic under „Recovery mode“. Then click „start“.

The progress of the update will be displayed using a status bar and confirmed at the end with „done“. The tool is now up-to-date with the current firmware and has the same settings as prior to the update.



NOTE

Do not pull out the USB cable during the update process!

4.4.15 Programming

Click on „Programming“ to access the Program settings menu. Here, for example, the speed, breakage detection and pressure control can be parametrised.

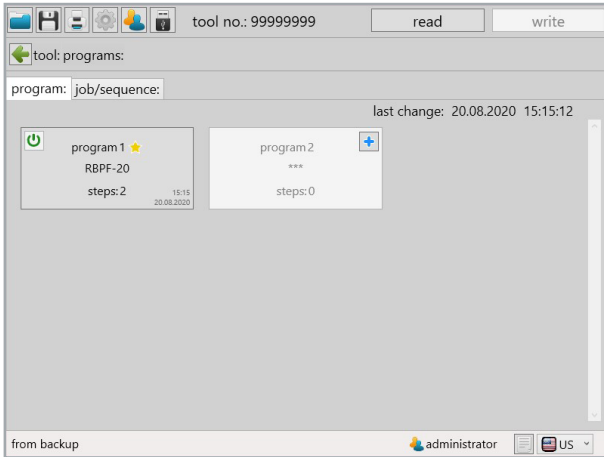

4.4.16 Program

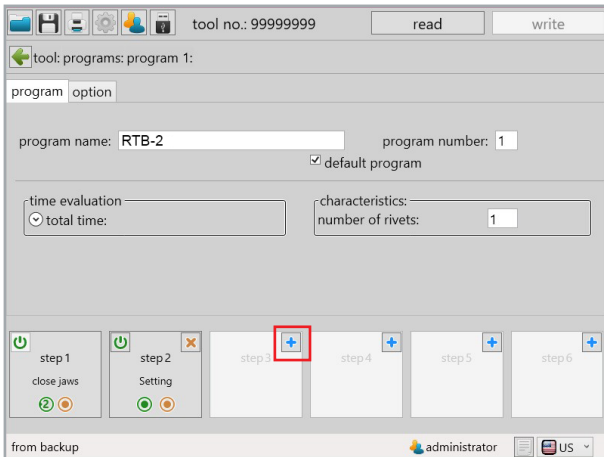

In program 1, up to 6 steps can be activated, each of which can be individually programmed. To parametrise a step individually, click on it. To create a new step, click on the small blue plus at the top right of the step.

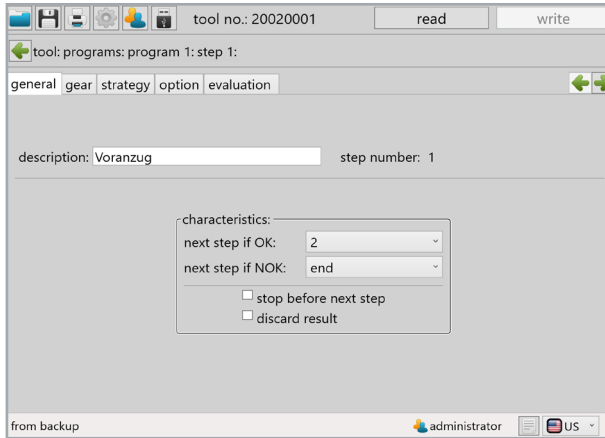

When you have clicked on a step, the summary appears in the picture above. The following settings can be made under „General“:

„next step if OK“	In the drop-down menu, you can select which action should follow if this step is completed OK, e.g. jump to the next step or end.
„next step if NOK“	In the drop-down menu, you can select which action should follow if this step is completed NOK, e.g. jump to the next step or end.
„stop before next step“	If the checkbox is selected, the tool stops when the step condition is reached (parametrised under Strategy).
„discard result“	If this option is activated, no evaluation is stored in the result file for this step.

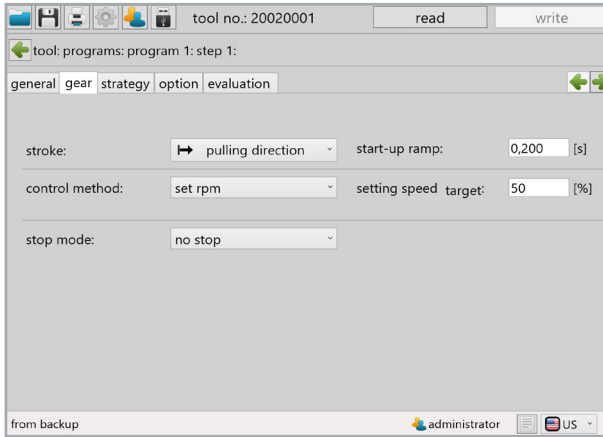

The settings for speed and pulling direction are made in the „gear“ tab.

„stroke“	The direction of the stroke is parametrised here. The default is „Pulling direction“. The „Starting position“ setting is only required for special applications. If you have any questions, please contact your Bossard partner.
„start-up ramp“	This time defines the ramp with which the motor moves to the target speed, recommended value 0.1 - 0.2 seconds.
„control method“	Adjustment of the engine control. „Setting speed“ is the default setting. In the „Control speed“ control mode, the tool keeps the speed constant even under load.
„regulate rpm“	The rpm control corresponds to a closed control loop. The tool will try to maintain the set speed even under load.
„set rpm“	The rpm control corresponds to an open control loop. The tool will not readjust the speed under load.
„rpm + force“	The rpm control is dependent on the measured force. Only possible when F_{Target} (NBPF-25) is activated
„setting speed _{Target} “	Adjustment of the setting speed in %. Recommended setting for screwing-on, level 1, 50%, for setting, level 2, 80 - 100%.
„setting speed _{min} “	Adjustment of the minimum setting speed

„shiftdown point“

Specifies the force from which the setting speed is to be reduced. Only available in the „Speed + force“ control mode.

„stop mode“

In the drop-down menu, it is possible to choose between "No stop" for switching between two steps and „ECO stop“ for the last step.

The settings for rivet setting are defined in the „strategy“ tab.

The individual functions can be activated by clicking on the On/Off symbol. A green symbol means active, greyed out means inactive.

RTB-20 and RTB-20-S

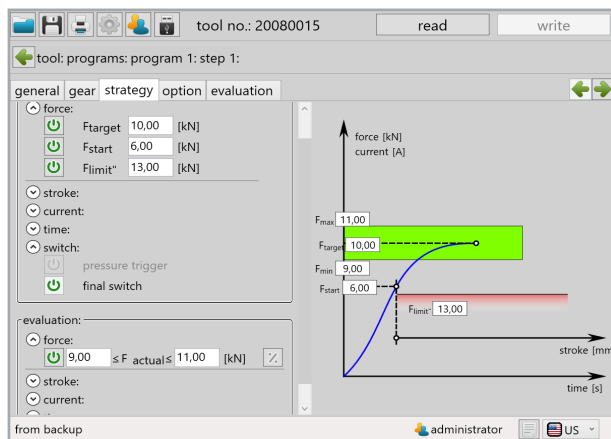

force

„ F_{Target} “

F_{Target} describes the force that the tool should achieve in this step. When this value is reached, the tool changes to the next step.

„ F_{Start} “

If F_{Target} is activated, F_{start} appears. This value defines the point at which the travel measurement for the setting step is to be started.

„ F_{limit} “

F_{limit} specifies the minimum force that must not be fallen short of during this step. Monitoring starts from F_{start} ; if the value falls below "Flimit" after this, the tool stops and displays an NOK error message.

stroke

„S_{Target}“ S_{Target} describes the stroke that the tool should travel in this step. When this value is reached, the tool changes to the next step.

„S_{limit}“ S_{Limit} describes the max. stroke the tool may cover in this step. When this value is reached, the tool stops and displays an NOK error message.

current

„I_{Target}“ I_{Target} describes the stroke that the tool should travel in this step. When this value is reached, the tool changes to the next step.

„I_{Start}“ If I_{Target} is activated, I_{start} appears. This value defines the point at which the travel measurement for the setting step is to be started.

„I_{limit}“ I_{limit} describes the max. current that the tool can reach in this step. When this value is reached, the tool stops and displays an NOK error message.



DANGER

Risk of injury due to incorrect parametrisation

Incorrect parametrisation can lead to injuries or damage

- Settings may only be made by experienced users.

time

„T_{Target}“ T_{Target} describes the time for which the tool should run in this step. When this value is reached, the tool changes to the next step.

„T_{limit}“ T_{limit} describes the max. time that the tool can run in this step. When this value is reached, the tool stops and displays an NOK error message.

switch

„pressure trigger“ If the Pressure trigger function is activated in the step, the pressure trigger must be activated. Default: deactivated

„final switch“ The limit switch function must always be activated so that the tool cannot move onto the block.

evaluation

„force“ The force value determines the force range in which the operating point must lie and evaluates the riveting process with OK or NOK.

„stroke“	The stroke value determines in which stroke range the operating point must lie and evaluates the riveting process with OK or NOK.
„current“	The current value determines the current range in which the operating point must lie and evaluates the riveting process with OK or NOK.
„time“	The time defines the time range in which the operating point must lie and evaluates the riveting process with OK or NOK.

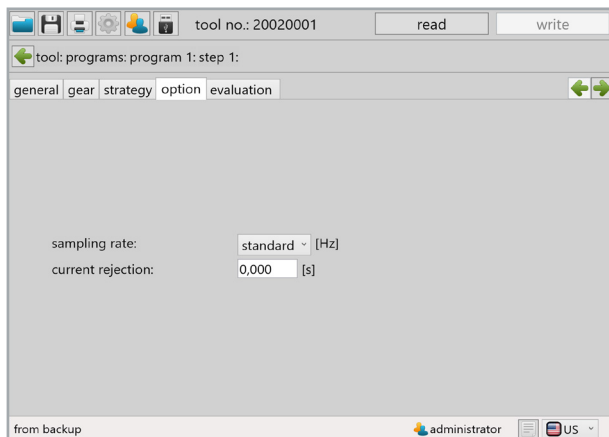

„sampling rate“	For each step, an individual sampling rate can be selected for the graphic recording. This allows the recording to be optimised. If „Standard“ is selected, the step is recorded with the value set under „Settings“ → „Graphics“ → „Sampling rate“ (chapter 4.4.11 on page 53).
„current rejection“	This function suppresses the starting current of the motor when using a current setting in the strategy. Recommended value: 0.25 seconds.

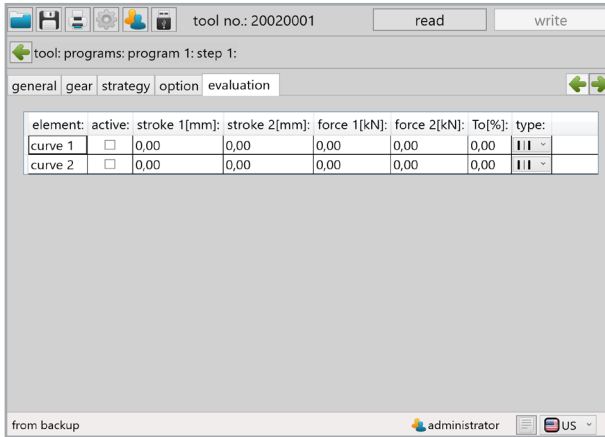

„evaluation“

Here you can define the travel and force range to be measured for each step.

4.4.17 Program → Option

The options for the program can be configured under Program Option.

„F_{min}“

F_{min} describes the minimum force for this step. If a force below this value is reached, no rivet has been set. The tool shows „Blank stroke“ or „Leerhub“ on the display, depending on the language setting



Anzeige mit Spracheinstellung
Englisch (default)



Anzeige mit Spracheinstellung
Deutsch

„pressure trigger“

The tool has a monitoring system that automatically detects the breakage of the rivet mandrel and causes the tool to move back to the starting position. Depending on the pulling head or fastener, breakage detection must be deactivated. Breakage detection is only active if the checkbox is enabled.

„QuickRiv-Technology“

The pressure control ensures that the blind rivet can only be processed when the pressure control is activated. This prevents accidental triggering and ensures that the components to be processed are in contact with each other. Pressure control is only active if the checkbox is enabled.

„confirm OK“

If this checkbox is selected, an OK setting must be acknowledged

„record graph F_{start}“

If this checkbox is selected, graphic recording starts from the entered force value.

„1×NOK → cancel job“

If this checkbox is selected, the program is aborted in the event of an NOK.

DANGER

Risk of injury from unavailable / deactivated pressure trigger



Tools without, or with deactivated, pressure trigger can be triggered without being placed on a part; significant risk of injury results from projectile rivets

- The tools may only be used by trained personnel
- Wear safety glasses and gloves
- Guide the rivet into the nose piece only directly before beginning the riveting process

The pressure trigger can not be used in the following tool types due to the system:

- BST-RTB-EX-1
- BST-RTB-EX-2
- BST-RTB-HUCK
- BST-RTB-Cherry

4.5 Maintenance and service

Apart from the regular cleaning and the inspection and maintenance of the clamping jaws the battery blind riveting device is largely maintenance-free.

WARNING



Risk of injury as a result of improper handling!

Improperly executed work can lead to hazards.

- Repair, maintenance and care of riveting tools must be completed professionally.
- After the work, no risk for the operator should exist during proper use.
- The operator may only conduct the work described here.

4.6 Cleaning



NOTE

Observe the following information for cleaning your riveting device. Incorrect cleaning solutions or improper procedures when cleaning can lead to damage to the riveting device.

4.6.1 General information

Do not use any degreasing or corrosive cleaning solutions and no water. Do not spray any cleaning solutions, solvents or easily flammable materials into the openings of the housing! The guide pipe for guiding the blind rivet in the collection container should be cleaned daily (carefully blown out from behind with compressed air), in order to remove dust and shavings.

Clean the battery contacts and the battery connection on the tool with a cloth, cotton swab and a little alcohol when necessary.



4.6.2 Clean clamping jaws

1. Loosen cap nut
2. Pull sleeve away towards the front
3. Pull lock toward the back and hold, loosen clamping jaw housing
4. Remove clamping jaws
5. Clean or replace clamping jaws
6. Lubricate clamping jaws
7. Check pressure spring
8. Install in reverse order, and ensure that the lock correctly locks the clamping jaw housing
9. Tighten the cap nut by hand



4.6.3 Service interval counter

The tool has an internal service interval counter which will inform the user of an inspection due. In this case you will receive the following notification in the display:



The service counters can be parametrised with the SmartTool-Manager under the „Service“ user. The respective value entered will be multiplied by 1,000, i.e. when entering 10 the service notification will appear on the display after 10,000 sets. If you enter 0 the function is deactivated.

The recommended service intervals are saved in the tool ex works. **We would be happy to inspect the tools for you after reaching the service interval.**

5 Storage

Observe the following information when storing riveters and chargers:

- Remove the battery when you are not using the riveting device.
- If you will not be using the battery for a longer period of time it should be stored, fully charged, in a dry, dust-proof area.
- Store the riveting device and charger in a dry environment protected against splashing water.
- Store the riveting device and charger in a well ventilated space and protected against exposure to dust.
- Ensure that the storage environment is free of aggressive chemicals and vapours.

6 Technical data

Description	RTB-20(-S)
Operating voltage	18 VDC
Device stroke	25 mm
Setting force	max. 20 kN
Setting speed	max. 37 mm/s
Noise emissions (L_{pA})	< 70 dB(A)
Measurement uncertainty (K)	3 dB(A)
Vibration (a_{nv})	< 2.5 m/s ²
Measurement uncertainty (K)	1.5 m/s ²
Operating altitude	< 2000 mNN
Operating temperature	10 - 40 °C
Storage temperature	0 - 50 °C
Dimensions (L × W × H)	approx. 302 × 73 × 270 mm
Weight without battery & traction head	approx. 1.7 kg
Weight with battery 2.5 Ah	approx. 2.0 kg
Weight with battery 5.0 Ah	approx. 2.3 kg
Feed-through	max. 6.3 mm
BST-LB-1825 battery	Li-Ion, 18 V, 2.5 Ah
BST-LB-1850 battery	Li-Ion, 18 V, 5.0 Ah
BST-BC-2830 charger	220 - 240 VAC, 50 - 60 Hz, 65 W
Suitable for blind rivets	2.4 - 6.4 mm (depending on material)

The values given for noise emissions and vibration were measured using a standardised test method and can be used for comparison with other power tools. They can also be used for a preliminary estimate of the load.



NOTE

The actual emissions can differ from the above information depending on the type and manner of use of the tool and, in particular, depending on the type of work-piece.

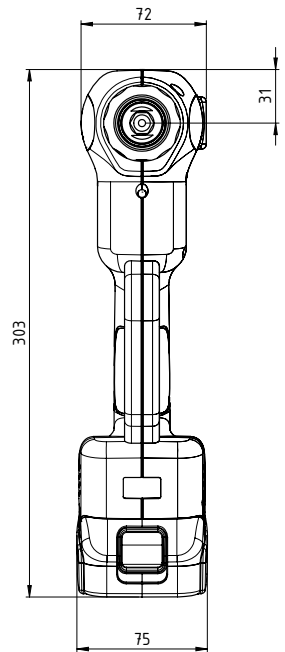
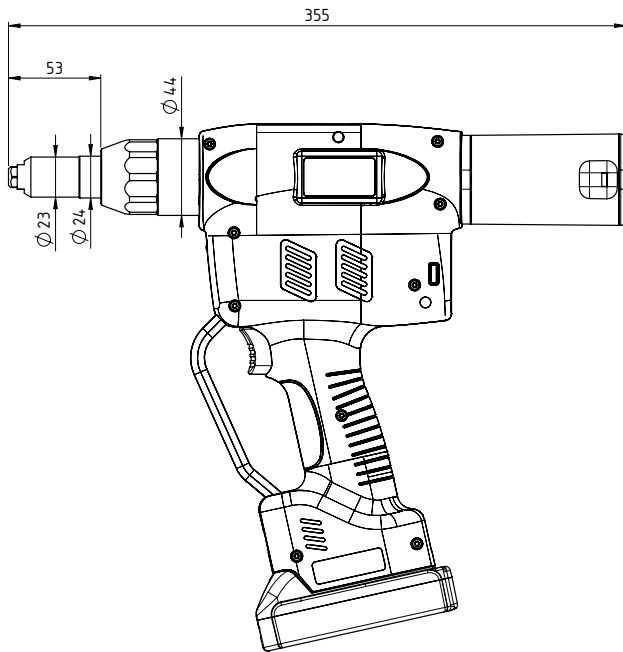

Specifications in mm
Not shown to scale

7 Troubleshooting and Fault repair

Bossard SmartTools are very stable and long-lasting tools.

If, however, a tool does not work properly you can find, and eliminate, the most frequent causes for errors in the table below.

Error	Possible cause	Remedy
Tool does not start, sound signal, red Light field appears	<ol style="list-style-type: none">1. Battery empty2. Defective battery	<ol style="list-style-type: none">1. Replace and charge battery2. Replace battery
Rivet does not break off	<ul style="list-style-type: none">- Dirt in clamping jaw- Clamping jaw is worn- Tool stroke too short for the rivet- Setting in the program configuration	<ul style="list-style-type: none">- Clean clamping jaws- Replace clamping jaw- Check which stroke is required for setting- Check setting

If the error still persists or is not listed, please contact your local Bossard customer service. You can also send general inquiries to this e-mail address: smartfactoryassembly@bossard.com

Please note the following information:

- Serial number of the riveting device (see battery compartment of the device)
- What error has occurred?
- Display
- When did the error first appear?
- What have you done to fix the error?

We reserve the right to make errors, technical changes to our products and changes to the delivery program in the course of further development.

CE Declaration of conformity

We, the manufacturer, hereby declare that the named tool complies with the essential protection requirements of the listed EU directives regarding design and construction type.

The prerequisite for this is the intended use of the tool as well as compliance with the installation and commissioning instructions.

If the product or its accessories are modified without our consent, this declaration becomes invalid.

Tool description:	Programmable cordless blind riveting tool
Type designation:	RBPF-x / Bossard SmartTool RTB-20(-S)
Manufacturer:	HS-Technik GmbH Im Martelacker 12 D-79588 Efringen-Kirchen
Directives:	2006/42/EU 2014/30/EU
Applied standards:	EN 62841-1:2015+AC:2015, EN 62841-2-2:2014 EN 61000-6-3:2007+A1:2011+AC:2012 EN 61000-6-2:2005+ AC:2005 EN 55014-1:2006+A1:2009+A2:2011 EN 55014-2:1997+ AC:1997+A1:2001+A2:2008

HS-Technik GmbH
Im Martelacker 12, D-79588 Efringen-Kirchen

January 2020



Florian Hanke
CEO

Notes

A series of horizontal dotted lines for writing notes, spanning the width of the page.

Notes

A series of horizontal dotted lines for writing notes, spanning the width of the page.

