

DIN 7500

White Paper

DIN 7500

by **Peter Witzke**

Head of Bossard Expert Team
Bossard Group

www.bossard.com

All rights reserved © 2020 Bossard

The recommendations and advices mentioned must be adequately checked by the reader in practical use and be approved as suitable for its application. Changes reserved.



ASSEMBLY
TECHNOLOGY
EXPERT

DIN 7500

Introduction

The DIN 7500 standard was first published in the late seventies and has been updated a number of times since. Simultaneously with the publication of DIN 7500-2 “guideline values for hole diameters” the standard for screws was named DIN 7500-1. However, most often the screws are just referred to as DIN 7500.

DIN 7500 screws are thread rolling screws for metals that form an ISO metric thread upon installation. For a great number of applications the total in-place costs and joint performance can be optimized at the same time. This is the reason why DIN 7500 screws have greatly increased in popularity over the years and continue to be the first choice fastener for many situations.

Unlike most fastener standards, DIN 7500-1 does not specify the geometry of the threaded part. It specifies what the screws must comply with in terms of performance and leaves it up to the manufacturer to decide the threaded shape. This is to encourage technical development, however in reality two basic thread shapes are commercially available worldwide:

Trilobular thread forming systems:

The screw thread has the characteristic trilobular cross-section along its entire length. They have the same diameter in the threaded section, irrespective of the orientation. During thread forming the compressive strains are concentrated on the 3 "edges." The mating material is more easily deformed this way.

Compressive strains in the flat areas of the trilobular thread cross section are very low. The material of the workpiece can relax into these and the risk of bursting is low, even in thin-walled internally threaded joint members.

The friction between screw thread and mating material is limited to the 3 "edges". The screws are coated with an invisible dry lubricant and installation torque is very low compared to other thread forming screws.

DIN 7500 trilobular screws are often referred to as "taptite" which is a registered trademark. Several brands and names can be found for this type of screw, but they are all based on the same principles and they all meet the requirements of DIN 7500-1.



Spiralform

Looking at worldwide usage, the Spiralform screw is of lesser significance compared to the trilobular thread forming systems.

The 4 lobes, positioned at 90° around the diameter of the screw and running spirally along the length of the thread, enable thread forming when the Spiralform screw is driven into the mating part.

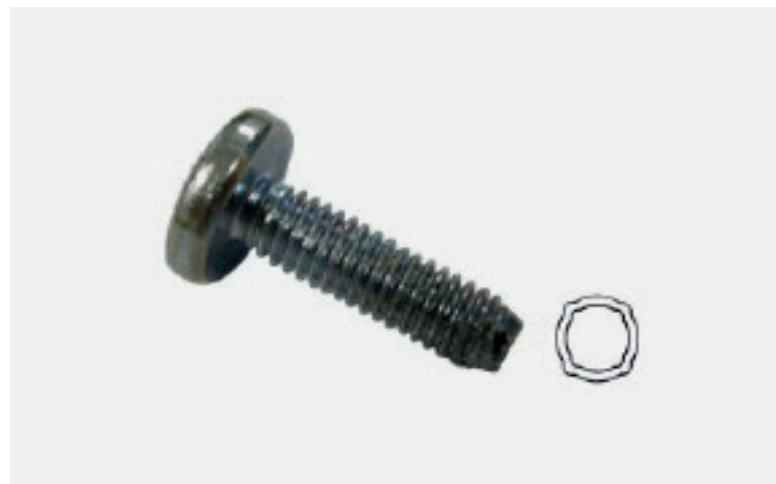

DIN 7500

Technical information and benefits

Basic function

As noted by the title of DIN 7500-1, the screws are thread rolling. This means that chips are not produced during the forming of the mating thread. This is especially important in the production of electrical and electronic equipment.

In comparison to a tapped thread a formed thread has greater strength due to work hardening of the material. Stripping resistance of the joint can be improved depending of the hardenability of the type of material that is used.

The costs of tapping operation and related processes can also be eliminated.

One feature that is important to notice is that the formed female thread is a nut thread with 6H tolerance. This facilitates a normal metric screw being fit into the formed female thread should the DIN 7500 screw be replaced.

Vibration resistance

Another important feature regarding the thread is that the play-free thread engagement of the screws and their friction secure assembled screws against rotational loosening. Locking elements such as those sometimes required for normal screws are not necessary when using DIN 7500 screws. Fastened joints are very cost-effective, with no procurement and assembly costs for spring lock washers, serrated lock washers, or locking adhesives.

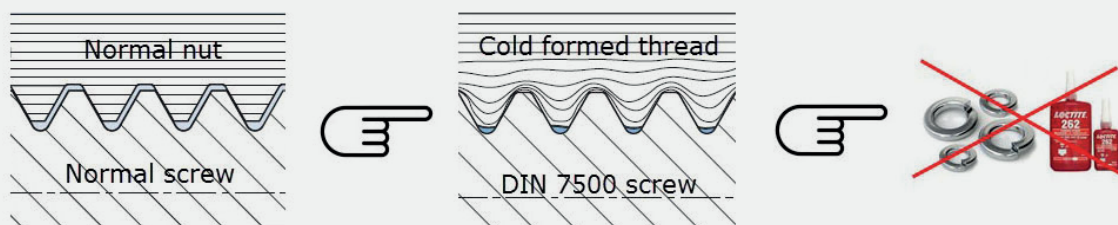

Mechanical properties

DIN 7500 screws are made from case-hardening steel. During heat treatment they obtain a hardness of min. 450 HV on the surface. The core is softer with a hardness of 290-370 HV to keep the screws relatively ductile. The hard surface is necessary for forming the thread in the mating part, and the screws can be installed into all malleable metals up to a maximum hardness of 135 HB (tensile strength $R_m = 450 \text{ N/mm}^2 \sim 65000 \text{ psi}$).

The tensile strength of these screws is not defined by the standard as they are case hardened. However, when tested the tensile strength is roughly the same as for property class 8.8 screws, although it is important to recall that their toughness is lower due to the case hardened surface.

DIN 7500 screws made of a strain-hardened austenitic A2 or A4 steel are also available. However, they can only be used in soft aluminum alloys.

Strength of the assembly

Pullout resistance of the screws is determined amongst other things by their thread engagement length. For normal screws, nuts usually have a height of 0.8x the nominal thread diameter d . This height is sufficient to prevent the nut threads from being stripped off.

Theoretically and under similar conditions the pullout resistance of a DIN 7500 screw is the same as that of conventional screws in tapped threads. The fact is, the pullout resistance of DIN 7500 screws is higher than that of regular screws! Reasons for the higher pullout resistance are:

1. The outside thread diameter is larger than for regular screws. Thus, the circumferential virtual cylinder around the engaged thread (shear-off surface in the clamped part) is larger than that for a regular screw.
2. No thread play (more engaged material).
3. The grain structure in the material of the mating part is not interrupted.
4. The material of the mating part is compressed and work hardened during thread forming.

DIN 7500

Pilot holes for counter threads

DIN 7500 screws are designed for multiple purposes. This is evident looking at the possible pilot hole configurations which are suitable for the screws. For detailed recommendations please see Bossard Catalog, Technical section or Bossard DIN 7500 brochure.

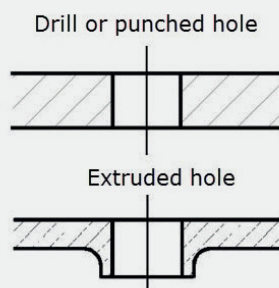

In the case of a punched hole the punching direction should correspond to the installation direction.

Tolerance of hole \varnothing H11.

By using extruded holes thinner sheets can be used. Special information regarding extrusion is available – contact Bossard Engineering for more information.

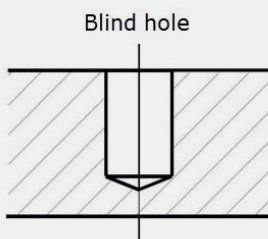

Thread-forming displaces material, so a small bulge is produced at the hole's entrance. This may prevent parts from being tightly fastened but a slight chamfer can prevent it.

Tolerance of hole \varnothing H11.

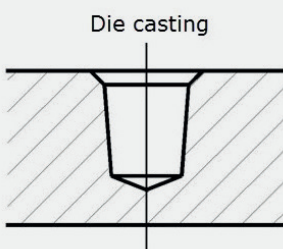

Die casting holes can be made as blind holes or through holes.

Design considerations regarding the thread end

DIN 7500 screws have a slightly cone-shaped thread end for insertion. Its length must not exceed 4x the thread pitch P . Designers must not consider this portion of the screw as load carrying. To ensure a full grip, e.g. in thinner metal sheets, the thread end must protrude.

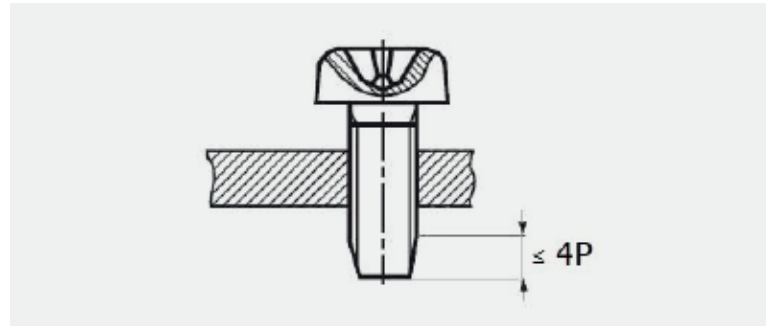

Assembly parameters

Thread forming screws have different driving torque characteristic than regular screws have in tapped internal threads.

Conventional screws drive in freely until their heads seat against the clamped part. From there, the torque increases to a certain calculated tightening torque. The goal is to induce a defined preload in the fastened joint.

In the case of thread forming screws, the driving torque increases with increasing thread engagement. They too are finally tightened. However, no defined preload can be achieved. The goal is only to sufficiently tighten them to keep the clamped parts in place. For the same reason these kinds of screws are not usually used in safety-critical applications that need verification by calculations.

Assembly guidelines recommend the size of the pilot hole and the amount of thread engagement (penetration depth of the screw) in the mating part – see Bossard Catalog, Technical section or Bossard DIN 7500 brochure.

These recommendations must be checked and optimized through practical application testing.

The applied tightening torque (3. M_A) should be between the maximum necessary thread forming torque (2. M_e) and the minimum thread stripping torque or screw breaking torque, whichever happens to be lower (4. M_u).

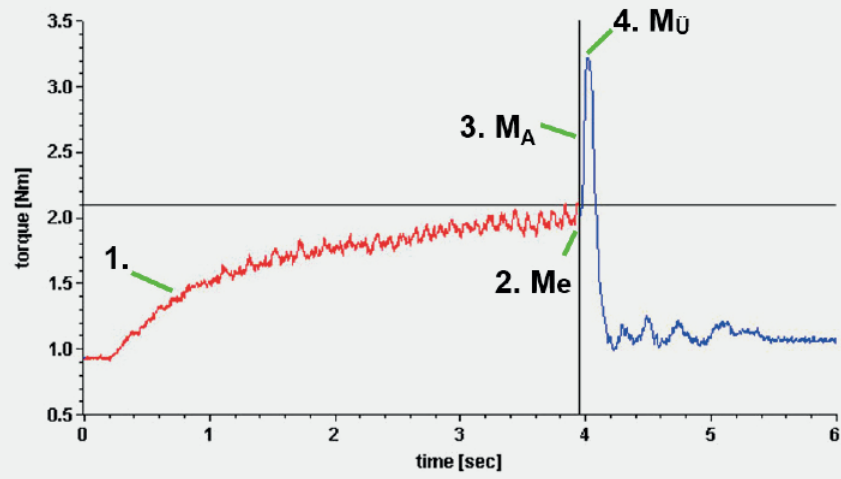

1. Thread forming
2. Thread forming torque M_e (surface contact between screw head and component)
3. Assembly torque M_A
4. Stripping/breaking torque $M_{\bar{u}}$

The determined assembly torque MA for a given DIN 7500 screw mainly depends on:

- Hardness of the material of the mating part.
- Material thickness when assembled in a through hole.
- Engagement depth when installed in a blind hole.
- Diameter of the pilot hole which the screw is assembled into.
- Friction conditions.

An assembly speed of maximum 1000 rpm is recommended. For some applications simple tools can determine the installation parameters. For others more advanced and precise equipment is needed. Such equipment is available from Bossard. Contact Bossard Engineering for more information.



Standard screws and special developments

A wide range of DIN 7500 screws is defined by the standard. However, a number of special developments are also available. One example is a special design for electrical devices where conductivity is required. Instead of having to use a toothed washer, small nibs are integrated underneath the head of the screw. This way only one fastener is needed and costs are optimized. Consult the Bossard Catalog for more information about available solutions.





If you need further assistance or have special finish requirements, please check out our contact page at www.bossard.com and talk to your nearest Bossard customer service representative.