



DIN 7500

Trilobular thread-forming system



“DIN7500 is an ISO metric thread forming screw for a great number of applications, optimal in-place costs and joint performance.”

Content

How it works and Advantages	4
Advantages	5
Materials, Corrosion Protection, Assembly, Technical Support	9
Product Overview	10

The Thread-Forming Screw

The Thread

Thread-forming screws according to DIN 7500 can be driven into malleable materials without the need for tapping the mating thread.

How it works?

Conventional, Tapped Hole

- Grain flow interrupted, not work hardened
- Produces chips and shavings
- There is play in threads
- Irregular thread flank surface

Thread is Formed by the Screw

- Grain flow redirected, work-hardened
- Produces no chips
- There is no play in the mating threads
- Smooth thread flank surface
- No additional locking elements needed

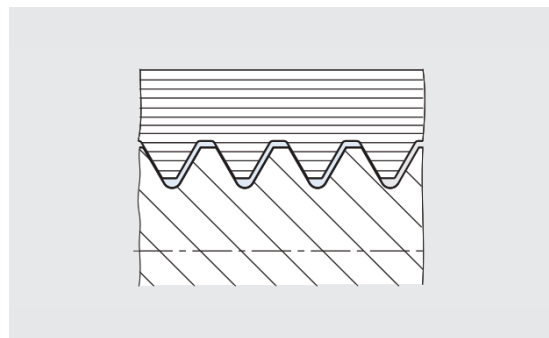
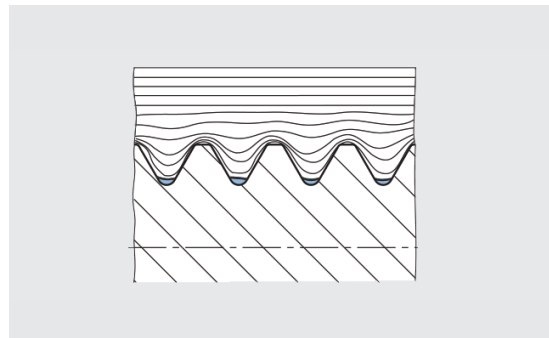

Simple - Reliable - Fast

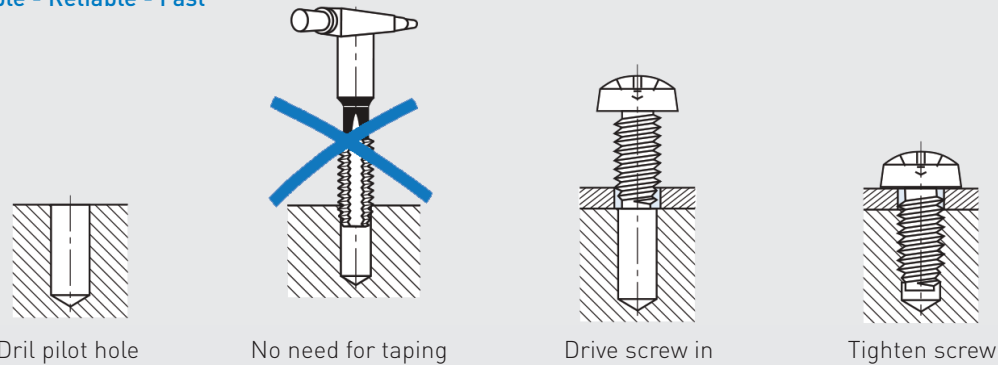

Drill pilot hole

No need for tapping

Drive screw in

Tighten screw

Advantages

Thread forming screws form their mating threads eliminating the need for tapping. The thread formed is a regular thread (metric or inch), meaning, thread-forming screws can be replaced with conventional screws.

Naturally, thread-forming screws may be used in tapped holes as well. Thus, the product range can be optimised.

Costs reduced by 20 to 30%

Conventional fastening technology	Multifunctional fastening technology
Screw DIN 7985 M4x10, 4.8, zinc plated with ribbed lock washers M4	Thread-forming screw DIN 7500 form C M4x10, steel zinc plated
Purchase screw Purchase lock washer	Purchase screw Purchase lock washer cost savings
Keep screw in inventory Keep lock washer in inventory	Keep screw in inventory Keep lock washer in inventory cost savings
Produce pilot hole: <ul style="list-style-type: none"> ▪ drill ▪ die-cast ▪ punch 	Produce pilot hole: <ul style="list-style-type: none"> ▪ drill ▪ die-cast ▪ punch
Tapping Chips removal Cleaning Inspecting, handling Temporary storage	Tapping Chips removal Cleaning Inspecting, handling Temporary storage cost savings
Install of screw Install of lock washer	Install of screw Install of lock washer cost savings

Based on years of experience, using thread-forming screws can reduce costs by up to 30%.

Subject to change without notice. Please refer to your local Bossard E-Shop for the current assortment and dimensions. Other variants upon request.

Simple, Reliable, Fast

The Trilobular Screw Thread

The trilobular thread shape facilitates thread forming. The tapered point eases thread engaging and initial thread forming.

The maximum taper length equals 4 thread pitches (max. 4xP). The tapered portion of the thread can not be fully loaded, which must be taken into account, when screw length is determined.

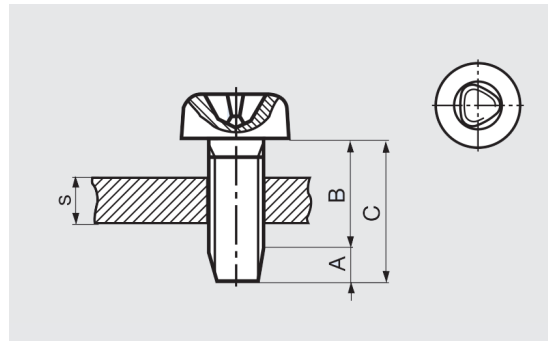

A Tapered screw point max. 4 P
B Load-bearing length
C Total length
S Thickness of material

Materials, Corrosion Protection

Thread-forming screws are normally made of zinc plated, case-hardened steel. The surface may be coated with wax or a similar lubricant to reduce the driving torque. The screws can therefore be installed into all malleable metals up to a maximum

hardness of 135 HB (tensile strength $R_m = 450 \text{ N/mm}^2 \sim 65000 \text{ psi}$).

On the other hand, thread-forming screws made from stainless steel A2 can only be used to fasten aluminum and non-ferrous metals.

Assembly

Ideally, thread forming screws are installed using automated fastening systems or manual power drivers with torque transducers (max. 1000 rpm). To start the thread forming process, screws must be slightly pressed into the pilot hole. Screws can be removed and re-installed at anytime for servicing and repair work.

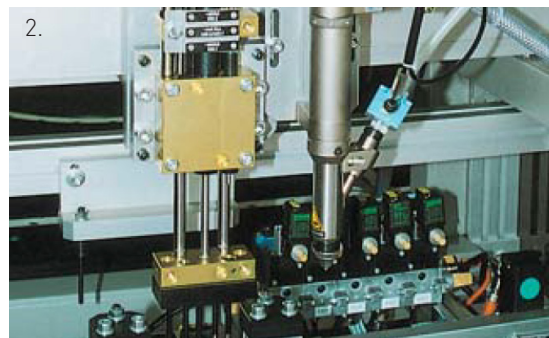

1. Installation with manual power driver
2. Installation with semi-automatic screwdriver

Subject to change without notice. Please refer to your local Bossard E-Shop for the current assortment and dimensions.
Other variants upon request.

Application Guidelines

Thread-forming displaces material, thus a small bulge is produced at the hole's entrance. This may prevent parts from being tightly fastened. A 90° chamfer, with a depth of 0.5 to 1 x the thread pitch, will avert that. A shallow relief bore will do the same. By putting a relief bore at the entrance of the pilot hole, the thread engagement of the individual assembled parts can be kept constant. This way, driving torques can be kept the same, assuming the screw diameter and material are the same. In thin sheet metals an extruded hole will increase pull-out force. Thread-forming screws are highly vibration resistant.

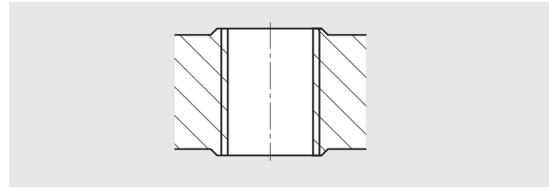

Screw installation without countersink (small bulge)

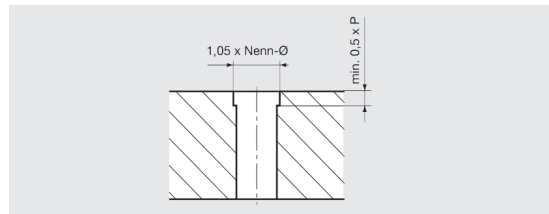

Relief bore

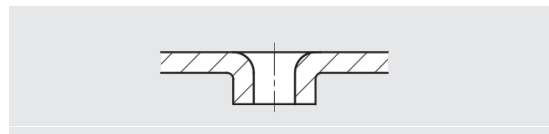

Extruded hole

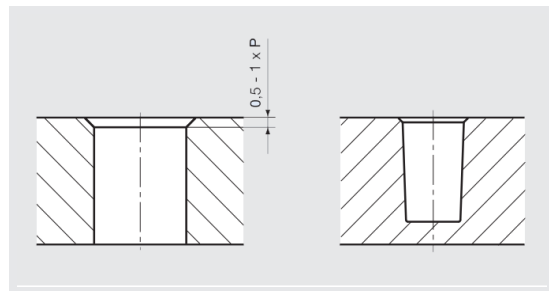

With countersinking, screw not yet installed

Technical Support and Testing

Whether a certain type of thread-forming screw is suitable for a given malleable material (steel, aluminum or non-ferrous metal) should be tested and evaluated through application testing.

Bossard engineers carry out application testing to assess thread forming screws, sizes M2.5 to M8, for specific customer applications. Findings and recommendations are then documented in a test report; the test reports typically include clear guidelines in terms of driving and tightening torques, pilot hole geometry, hole diameter and engagement length.

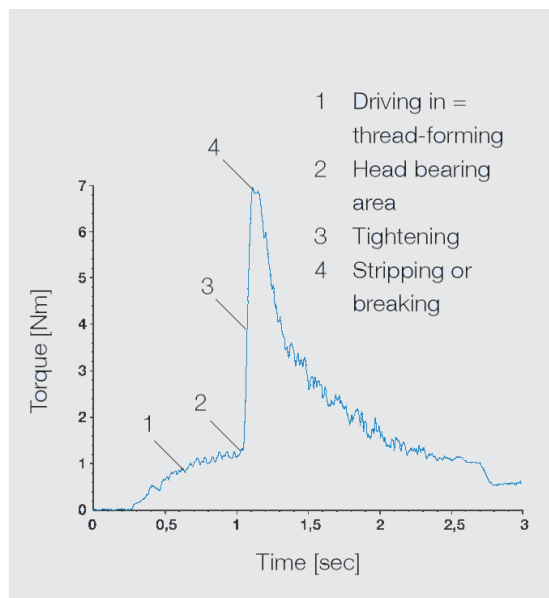
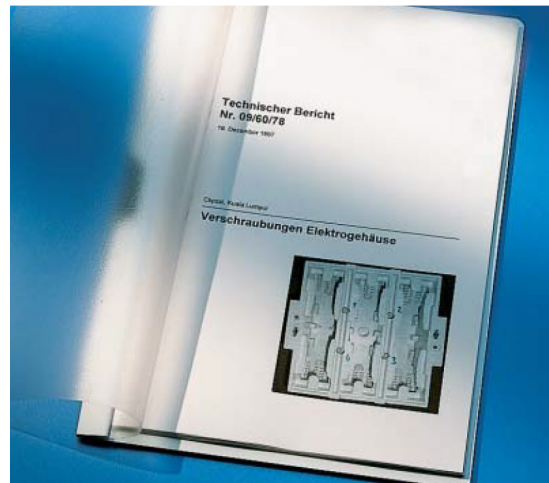

Subject to change without notice. Please refer to your local Bossard E-Shop for the current assortment and dimensions. Other variants upon request.

Information Concerning Pilot Data Holes

Thread-forming screws can be installed in blind holes as well as through holes. Type and strength of material of the mating components, hole geometry and size, and engagement length are decisive for a proper installation. That information can be found in the tables to the left.

Data		Nominal diameter							
		M2	M2,5	M3	M3,5	M4	M5	M6	M8
Thread pitch	(mm)	0,4	0,45	0,5	0,6	0,7	0,8	1	1,25
Tightening torque max.		ca. 80% of the breaking torque							
Breaking torque min.	(Nm)	0,4	1	1,8	2,8	4,1	8,7	15	37
Tensile force min.	(kN)	1,65	2,7	4	5,4	7	11,4	16	29
Thickness of material	(mm)	Pilot hole Ø – H11 for steel, HRB 77 max.; drilled or punched							
2 and smaller		1,8	2,25	2,7	3,2	3,6	4,5	5,4	7,25
4		1,85	2,3	2,75	3,2	3,65	4,55	5,45	7,25
6			2,35	2,75	3,2	3,7	4,6	5,5	7,4
8						3,7	4,65	5,55	7,4
10							4,65	5,55	7,5
12									7,5
14									7,5

Pilot Holes for Aluminum Die-Cast

t₁ (mm):

The hole entrance is furnished with a chamfer to: facilitate the die casting process, Strengthen the casting pin, ease the locating of holes (screw is guided into hole), prevent material build-up on the hole entrance, enable the use of cost-efficient nominal screw lengths t₂ / t₃ (mm):

Load-bearing engagement length, taper angle maximum 1°.

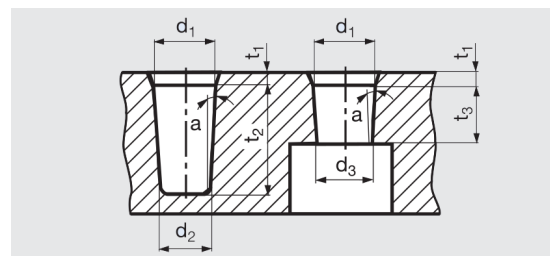

Nominal diameter		M2	M2,5	M3	M3,5	M4	M5	M6	M8	
d ₁ ¹¹	(mm)	1,9	2,36	2,86	3,32	3,78	4,77	5,69	7,63	
d ₂ ¹¹	(mm)	1,75	2,2	2,67	3,11	3,54	4,5	5,37	7,24	
d ₃ ¹¹	(mm)	1,8	2,27	2,76	3,23	3,64	4,6	5,48	7,35	
¹¹ for d ₁ , d ₂ , d ₃	Tolerance +	(mm)	0	0	0	0	0	0	0	
	Tolerance -	(mm)	0,04	0,06	0,06	0,075	0,075	0,075	0,075	0,09
t ₁ x 45°	(mm)	variable, minimum 1 x thread pitch P								
t ₂ ²¹	(mm)	4,3	5,3	6	6,9	7,8	9,2	11	14	
²¹ for t ₂	Tolerance	(mm)	0,2	0,2	0,2	0,6	0,5	0,5	0,5	0,5
		(mm)	0	0	0	0	0	0	0	0
t ₃	(mm)	2	2,5	3	3,5	4	5	6	8	

All design recommendation should be verified through application testing.

Subject to change without notice. Please refer to your local Bossard E-Shop for the current assortment and dimensions. Other variants upon request.

PRODUCT OVERVIEW

The Thread-Forming Screw DIN 7500

Thread-Forming Screw Head **DIN 7985** with Pozidriv cross recessed pan

● **BN 2724** | Case hardened, zinc plated, waxed

● **BN 4908** | INOX A2, waxed

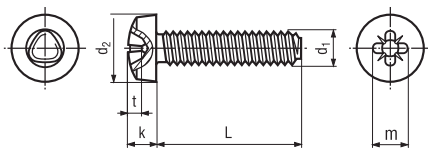

d ₁	M2,5	M3	M4	M5	M6
d ₂ max.	5	6	8	10	12
k max.	2,12	2,52	3,25	3,95	4,75
⊕	1	1	2	2	3
m ~	2,6	3	4,3	5	6,7
t min.	1,27	1,68	1,9	2,64	3,02
t max.	1,52	1,93	2,36	3,01	3,48

d ₁	M2,5	M3	M4	M5	M6
4	●				
5	● ●	● ●			
6	● ●	● ●	● ●		
8	● ●	● ●	● ●	● ●	
10	● ●	● ●	● ●	● ●	● ●
L 12	●	● ●	● ●	● ●	● ●
16	●	● ●	● ●	● ●	● ●
20	●	● ●	● ●	● ●	● ●
25			● ●	● ●	● ●
30			● ●	● ●	● ●
40					●

Hexalobular pan head thread forming screws ~Form C Head ~**DIN 7985**

● **BN 13916** | Case hardened, zinc plated, waxed

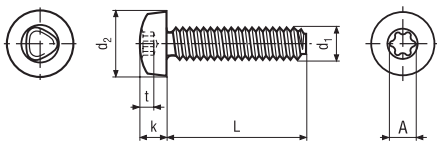

d ₁	M2,5	M2,5	M3	M4	M5	M6	M8
d ₂ max.	4	5	6	8	10	12	16
k max.	1,72	2,12	2,52	3,25	3,95	4,75	6,15
⊕	X6	X8	X10	X20	X25	X30	X40
t max.	0,8	1,2	1,3	1,8	2	2,4	3,3
A ~	1,8	2,4	2,8	3,9	4,5	5,6	6,8

d ₁	M2	M2,5	M3	M4	M5	M6	M8
3	●						
4	●	●					
5	●	●	●				
6	●	●	●	●			
8	●	●	●	●	●		
10	●	●	●	●	●	●	
L 12	●	●	●	●	●	●	
16		●	●	●	●	●	●
20		●	●	●	●	●	●
25			●	●	●	●	●
30			●	●	●	●	●
35				●	●	●	●
40				●	●	●	●

Subject to change without notice. Please refer to your local Bossard E-Shop for the current assortment and dimensions.
Other variants upon request.

Hexalobular pan head thread forming screws ~Form C Head ISO 14583

● **BN 5653** | INOX A2, waxed

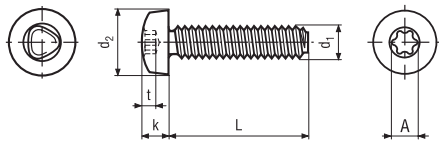

d ₁	M2,5	M3	M4	M5	M6
d ₂ max.	5	5,6	8	9,5	12
k max.	2,1	2,4	3,1	3,7	4,6
⊕	X8	X10	X20	X25	X30
t max.	1,04	1,27	1,66	1,91	2,42
A ~	2,4	2,8	4,0	4,5	5,6

d ₁	M2,5	M3	M4	M5	M6
4	●				
5	●	●			
6	●	●	●		
8	●	●	●	●	
10	●	●	●	●	●
12	●	●	●	●	●
16		●	●	●	●
20		●	●	●	●
25			●	●	●
30			●	●	●

Thread forming screws with Pozidriv cross recessed cheese head with metric head

● **BN 2723** | Case hardened, zinc plated, waxed

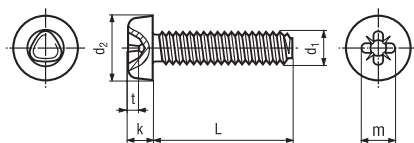

d ₁	M2,5	M3	M4	M5	M6
d ₂ max.	4,5	5,5	7	8,5	10
k max.	1,9	2,3	2,9	3,7	4,3
⊕	1	1	2	2	3
m ~	2,4	2,9	4,3	4,7	6,3
t min.	1,1	1,6	1,9	2,3	2,5
t max.	1,35	1,85	2,35	2,75	2,97

d ₁	M2,5	M3	M4	M5	M6
6	●	●	●		
8	●	●	●	●	
10	●	●	●	●	●
12	●	●	●	●	●
16	●	●	●	●	●
20		●	●	●	●
25		●	●	●	●
30					●

Subject to change without notice. Please refer to your local Bossard E-Shop for the current assortment and dimensions. Other variants upon request.

Thread forming screws with Pozidriv cross recessed flat head with metric thread

● **BN 3327** | case hardened, zinc plated, waxed

● **BN 4919** | INOX A2, waxed

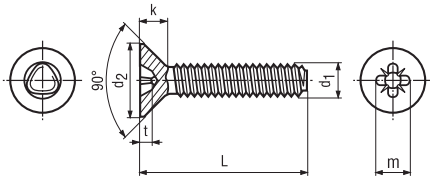

d ₁	M2,5	M3	M4	M5	M6	
d ₂ max.	4,7	5,6	7,5	9,2	11	
k max.	1,5	1,65	2,2	2,5	3	
⊕	1	1	2	2	3	
m ~	2,5	2,8	4	4,4	6,1	
t	min.	1,22	1,48	1,6	2,05	2,46
	max.	1,47	1,73	2,06	2,51	2,92

d ₁	M2,5	M3	M4	M5	M6
5	●				
6	●	●			
8	●	●	●	●	
10	●	●	●	●	●
L 12	●	●	●	●	●
16	●	●	●	●	●
20		●	●	●	●
25		●	●	●	●
30				●	●

Hexalobular flat head thread forming screws with metric thread

● **BN 11288** | Case-hardened, zinc plated, waxed

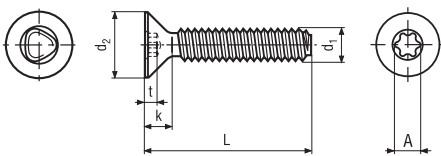

d ₁	M2,5	M2,5	M3	M4	M5	M6	M8
d ₂ max.	3,8	4,7	5,6	7,5	9,2	11	14,5
k max.	1,2	1,5	1,65	2,2	2,5	3	4
⊕	X6	X8	X10	X20	X25	X30	X40
t max.	0,7	1	1	1,4	1,5	1,9	3,3
A ~	1,8	2,4	2,8	3,9	4,5	5,6	6,8

d ₁	M2	M2,5	M3	M4	M5	M6	M8
3	●						
4	●	●					
5	●	●					
6	●	●	●				
8	●	●	●	●	●		
10	●	●	●	●	●	●	
L 12	●	●	●	●	●	●	●
16		●	●	●	●	●	●
20			●	●	●	●	●
25				●	●	●	●
30				●	●	●	●
35							●
40							●

Subject to change without notice. Please refer to your local Bossard E-Shop for the current assortment and dimensions.
Other variants upon request.

Hexalobular flat head thread forming screws with metric thread

● **BN 13278** | INOX A2, waxed

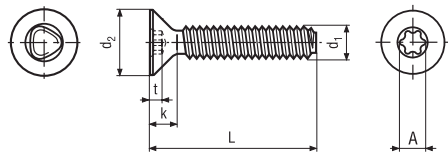

d ₁	M2,5	M3	M4	M5	M6
d ₂ max.	4,7	5,5	8,4	9,3	11,3
k max.	1,5	1,65	2,7	2,7	3,3
⊙	X8	X10	X20	X25	X30
t max.	0,79	0,83	1,53	1,51	1,78
A ~	2,4	2,8	4,0	4,5	5,6

d ₁	M2,5	M3	M4	M5	M6
5	●				
6	●	●			
8	●	●	●		
10	●	●	●	●	●
L 12	●	●	●	●	●
16		●	●	●	●
20		●	●	●	●
25		●	●	●	●
30			●	●	●

Thread forming screws hex head with flange and metric head

● **BN 3326** | Case-hardened zinc plated, waxed

● **BN 10812** | INOX A2, waxed

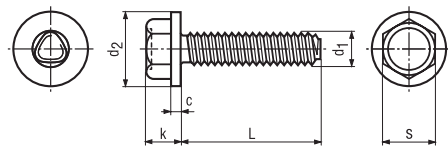

d ₁	M4	M5	M6	M8
d ₂ max.	8,9	10,4	13	17
k max.	4,23	5,25	6,25	8,35
c max.	0,65	0,8	1,05	1,35
s	7	8	10	13

d ₁	M4	M5	M6	M8
5	●	●		
6	●	●	●	●
8	●	●	●	●
12	●	●	●	●
L 16	●	●	●	●
20	●	●	●	●
25	●	●	●	●
30		●	●	●

Subject to change without notice. Please refer to your local Bossard E-Shop for the current assortment and dimensions.
Other variants upon request.

Hexalobular pan head thread forming screws with ribs and metric thread

● **BN 14551** | Case-hardened zinc plated, waxed

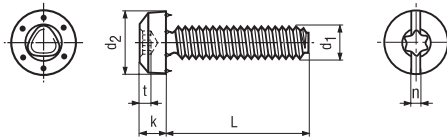

d ₁	M3	M4
d ₂ max.	6	8
k max.	2,52	3,25
n	0,6	1
⊕	X10	x20
t max.	1,2	1,9

d ₁	M3	M4
5	●	
6	●	●
8	●	●
L		
10		●
12		●
16		

Electrical Grounding without Extra Cost - Thanks to Grounding Screws with Nibs

This screw is furnished with nibs underneath the head. The nibs generate electrical contact by penetrating the coated surface of the clamped components. These nibs also increases vibration resistance.



1.



2.

1. Thread-forming grounding screws
2. Cost-savings example of light fixture assembly

Subject to change without notice. Please refer to your local Bossard E-Shop for the current assortment and dimensions. Other variants upon request.

PROVEN PRODUCTIVITY – A PROMISE TO OUR CUSTOMERS

The strategy for success

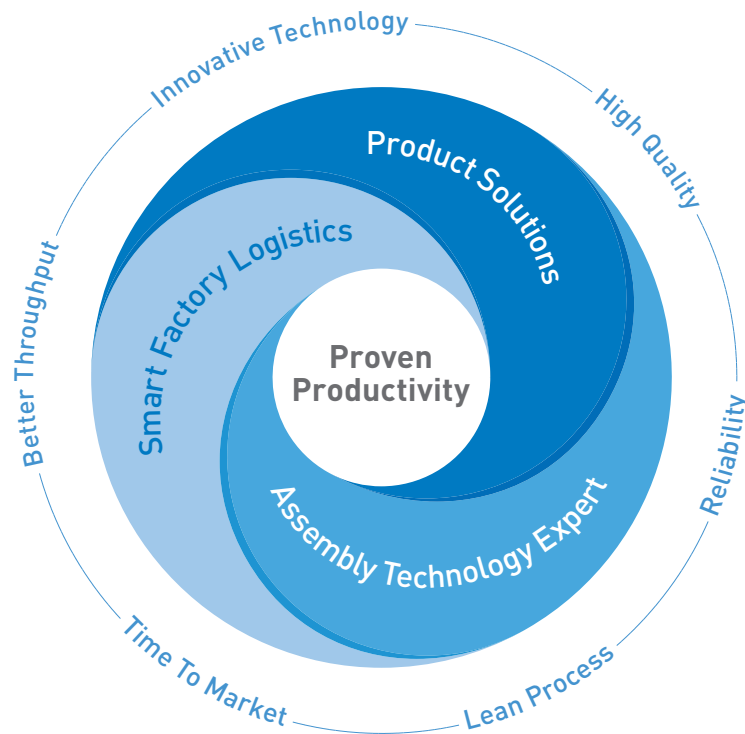

From years of cooperation with our customers we know what achieves proven and sustainable impact. We have identified what it takes to strengthen the competitiveness of our customers. Therefore we support our customers in three strategic core areas.

Firstly, when finding optimal **Product Solutions**, that is in the evaluation and use of the best fastening part for the particular function intended in our customers' products.

Second, our **Assembly Technology Expert** services deliver the smartest solutions for all possible fastening challenges. Our services cover from the moment our customers developing a new product, to

assembly process optimization as well as fastening technology education for our customers' employees.

And thirdly, optimising our clients' productions in a smart and lean way with **Smart Factory Logistics**, our methodology, with intelligent logistics systems and tailor-made solutions.

Understood as a promise to our customers, "Proven Productivity" contains two elements: Firstly, that it demonstrably works. And secondly, that it sustainably and measurably improves the productivity and competitiveness of our customers.

And this for us is a philosophy which motivates us every day to always be one step ahead.

www.bossard.com