



Key locking inserts

Certainly the perfect fit for heavy duty applications



“Key locking inserts are extremely durable and withstand numerous loosening and tightening cycles without thread stripping.”

Contents

Characteristics	4
Tool, installation	5
Threaded inserts with 2 key locks	6
Threaded inserts with 2 key locks, self-locking	7
Threaded inserts with 4 key locks	8
Threaded inserts with 4 key locks, self-locking	9

Technical performances, installation recommendations as well as unspecified tolerances regarding the dimensions of the parts have to be requested individual for each application before starting the series production.

All dimensions are specified in mm.

CHARACTERISTICS

Key locking inserts

A guaranteed reliable fastening solution.

Key locking inserts are the perfect solution to prevent threads from becoming stripped in fields like mechanical or precision engineering, aviation and aerospace. Key locking inserts are made of stainless steel 1.4305 / AISI 303. They are extremely durable and withstand numerous loosening and tightening cycles without thread stripping. They can be readily used in light metal, steel or cast iron application. They can also be used as an easy and efficient replacement for damaged threads in expensive components.

Key locking inserts are preassembled with special keys that lock the key locking inserts into place to absolutely eliminate rotation and vibration even in heavy-duty applications. Depending on the tread size, key locking inserts are available with two or four key locks, both either with normal or self-locking thread.

Benefits

- Easy installation
- Highly durable
- Repair of damaged threads
- Pre-assembled key locks

3-D Data: <https://bossard.partcommunity.com/3d-cad-models>

TOOL FOR THREADED INSERTS WITH 2 OR 4 KEY LOCKS

Tool | Installation

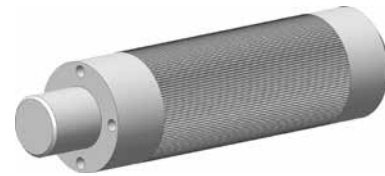

Internal thread KEENSERTS®	Types KNCM small series and KNM, KNML	Types KNHM, KNHML heavy duty series
	Order reference	Order reference
M3	KRTM 3 - 01	
M4	KRTM 4 - 01	
M5	KRTM 5 - 01	KRTM 5 - 02
M6	KRTM 6 - 01	KRTM 6 - 02
M8	KRTM 8 - 01	KRTM 8 - 02
M10	KRTM 10 - 01	KRTM 10 - 02
M12	KRTM 12 - 01	KRTM 12 - 02
M16		KRTM 16 - 02

Installation

1. Manually screw the key locking inserts on the mandrel using 2 - 3 turns.
2. Attach the installation tool, including the spigot, and turn it until the key locks snap in the bore hole. Continue the screwing process until the key locking inserts is fully screwed in.
3. Hitting the tool with a hammer, drive the snapped in key locks in until they touch the material.
4. Slightly lift the tool and it turn clockwise by about 45°.
5. Hitting the tool with a hammer, drive the keylocks in completely until the tool is once again flush with the surface.
6. Installation complete.

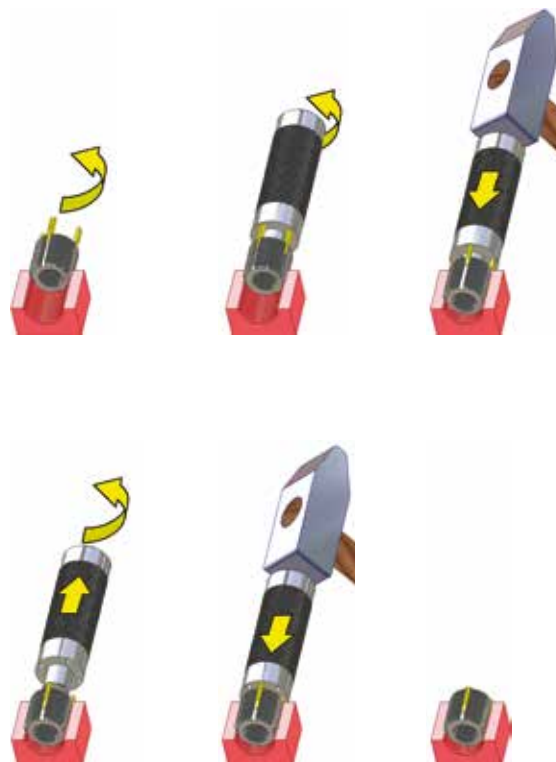

2 KEY LOCKS

Threaded inserts



Types KNCM, KNM, KNHM

Material

Stainless steel 1.4305 / AISI 303

Extraction force [N]

Shear engagement „A [mm²]“ x ultimate shear strength of parent material „R_m [N/mm²]“

Key locking inserts with UNC or UNF threads, MS and NAS specification are available upon request.

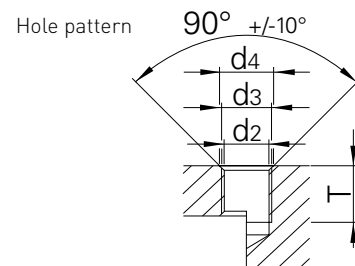
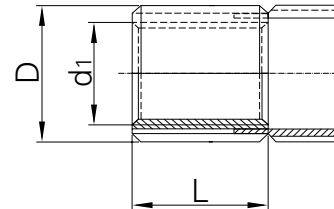

Ordering data example: BN 38025 - M3

BN 38025 – Type KNCM, small series

Thread size d ₁ 5H	Thread size D 4h	Code	L ± 0,25	d ₂	d ₃ 6H	d ₄	T min.	A [mm ²]
M3	M5x0,80	KNCM3x0,5	4,25	4,4	M5x0,80	5,1	6,0	33,1
M4	M6x0,75	KNCM4x0,7	5,25	5,5	M6x0,75	6,1	7,5	58,4

BN 38036 – Type KNM, standard series

Thread size d ₁ 5H	Thread size D 4h	Code	L ± 0,3	d ₂	d ₃ 6H	d ₄	T min.	A [mm ²]
M5	M8x1,25	KNM5x0,8	8,0	6,9	M8x1,25	8,25	10,5	104,9
M6	M10x1,25	KNM6x1	10,0	8,8	M10x1,25	10,25	13,0	177,7

BN 38028 – Type KNHM, heavy-duty series

Thread size d ₁ 5H	Thread size D 4h	Code	L ± 0,3	d ₂	d ₃ 6H	d ₄	T min.	A [mm ²]
M5	M10x1,25	KNHM5x0,8	10,0	8,8	M10x1,25	10,25	13,0	177,7
M6	M12x1,25	KNHM6x1	12,0	10,8	M12x1,25	12,25	15,5	266,7

Subject to change without notice. Please refer to your local Bossard E-Shop for the current assortment and dimensions.
Other variants upon request.

2 KEY LOCKS, SELF-LOCKING

Threaded inserts



Types KNML, KNHML

The self-locking feature is designed similarly to MIL-N-25027 and supplied with MIL-L8937 lubrication.

Material

Stainless steel 1.4305 / AISI 303 with Molykote® surface treatment

Extraction force [N]

Shear engagement „A [mm²]“ x ultimate shear strength of parent material „R_m [N/mm²]“

Key locking inserts with UNC or UNF threads, MS and NAS specification are available upon request.

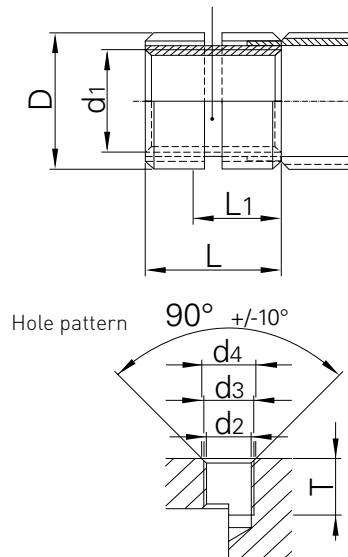

Ordering data example: BN 38068 - M5

BN 38068 – Type KNML, standard series

Thread size d ₁ 5H	Thread size D 4h	Code	L ± 0,3	L ₁ * L ₁	d ₂ 	d ₃ 6H	d ₄	T min.	A [mm ²]
M5	M8 x1,25	KNML5x0,8	8,0	7,6	6,9	M8x1,25	8,25	10,5	83,1
M6	M10x1,25	KNML6x1	10,0	8,2	8,8	M10x1,25	10,25	13,0	152,7

BN 38552 – Type KNHML, heavy-duty series

Thread size d ₁ 5H	Thread size D 4h	Code	L ± 0,3	L ₁ * L ₁	d ₂ 	d ₃ 6H	d ₄	T min.	A [mm ²]
M5	M10x1,25	KNHML5x0,8	10,0	8,7	8,8	M10x1,25	10,25	13,0	152,7
M6	M12x1,25	KNHML6x1	12,0	9,5	10,8	M12x1,25	12,25	15,5	242,5

* L₁ = minimum screw-in depth

Subject to change without notice. Please refer to your local Bossard E-Shop for the current assortment and dimensions.
Other variants upon request.

4 KEY LOCKS

Threaded inserts



Types KNM, KNHM

Material

Stainless steel 1.4305 / AISI 303

Extraction force [N]

Shear engagement „A [mm²]“ x ultimate shear strength of parent material „R_m [N/mm²]“

Key locking inserts with UNC or UNF threads, MS and NAS specification are available upon request.

Ordering data example: BN 53532 - M8

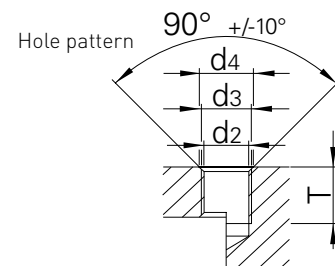
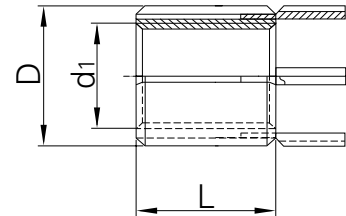

BN 53532 – Typ KNM, standard series

Thread size d ₁ 5H	Thread size D 4h	Code	L ± 0,3	d ₂	d ₃ 6H	d ₄	T min.	A [mm ²]
M8	M12x1,25	KNM8x1,25	12,0	10,80	M12x1,25	12,25	15,5	266,7
M10	M14x1,50	KNM10x1,5	14,0	12,80	M14x1,50	14,25	18,0	341,6
M12	M16x1,50	KNM12x1,75	16,0	14,75	M16x1,50	16,25	20,0	470,2

BN 53533 – Typ KNHM, heavy duty series

Thread size d ₁ 5H	Thread size D 4h	Code	L ± 0,3	d ₂	d ₃ 6H	d ₄	T min.	A [mm ²]
M8	M14x1,50	KNHM8x1,25	14,0	12,80	M14x1,5	14,25	18,0	341,6
M10	M16x1,50	KNHM10x1,5	16,0	14,75	M16x1,5	16,25	20,0	470,2
M12	M18x1,50	KNHM12x1,75	18,0	16,75	M18x1,5	18,25	23,0	608,5
M16	M22x1,50	KNHM16x2	22,0	20,50	M22x1,5	22,25	27,0	896,8

Subject to change without notice. Please refer to your local Bossard E-Shop for the current assortment and dimensions.
Other variants upon request.

4 KEY LOCKS, SELF-LOCKING

Threaded inserts



Types KNML, KNHML

The self-locking feature is designed similarly to MIL-N-25027 and supplied with MIL-L8937 lubrication.

Material

Stainless steel 1.4305 / AISI 303 with Molykote® surface treatment

Extraction force [N]

Shear engagement „A [mm²]“ x ultimate shear strength of parent material „R_m [N/mm²]“

Key locking inserts with UNC or UNF threads, MS and NAS specification are available upon request.

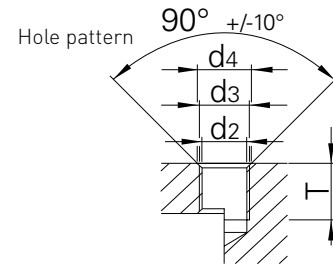
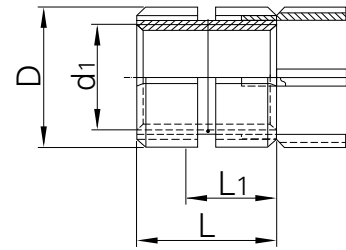

Ordering data example: BN 38037 - M8

BN 38037 – Typ KNML, standard series

Thread size d ₁ 5H	Thread size D 4h	Code	L ± 0,3	L ₁ * L ₁	d ₂ 	d ₃ 6H	d ₄	T min.	A [mm ²]
M8	M12x1,25	KNML8x1,25	12,0	9,5	10,80	M12x1,25	12,25	15,5	242,5
M10	M14x1,50	KNML10x1,5	14,0	10,0	12,80	M14x1,50	14,25	18,0	316,4
M12	M16x1,50	KNML12x1,75	16,0	11,2	14,75	M16x1,50	16,25	20,0	441,4

BN 38029 – Typ KNHML, heavy duty series

Thread size d ₁ 5H	Thread size D 4h	Code	L ± 0,3	L ₁ * L ₁	d ₂ 	d ₃ 6H	d ₄	T min.	A [mm ²]
M8	M14x1,50	KNHML8x1,25	14,0	10,0	12,80	M14x1,5	14,25	18,0	316,4
M10	M16x1,50	KNHML10x1,5	16,0	10,0	14,75	M16x1,5	16,25	20,0	441,4
M12	M18x1,50	KNHML12x1,75	18,0	10,7	16,75	M18x1,5	18,25	23,0	561,8
M16	M22x1,50	KNHML16x2	22,0	12,4	20,50	M22x1,5	22,25	27,0	855,2

* L₁ = minimum screw-in depth

Subject to change without notice. Please refer to your local Bossard E-Shop for the current assortment and dimensions.
Other variants upon request.



“Key locking inserts are pre-assembled with special keys that lock the key locking inserts into place to absolutely eliminate rotation and vibration even in heavy-duty applications.”

Find out more at: www.bossard.com

PROVEN PRODUCTIVITY – A PROMISE TO OUR CUSTOMERS

The strategy for success

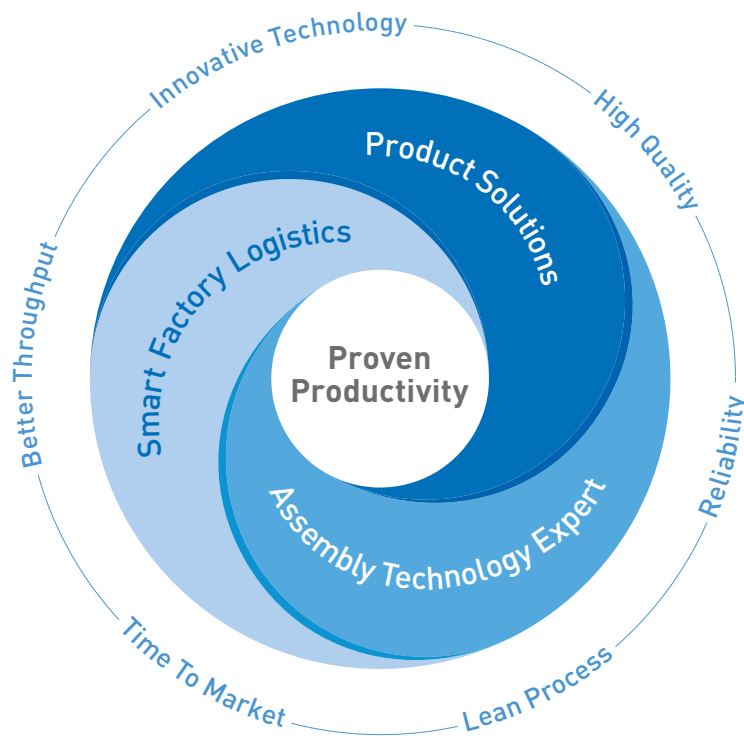

From years of cooperation with our customers we know what achieves proven and sustainable impact. We have identified what it takes to strengthen the competitiveness of our customers. Therefore we support our customers in three strategic core areas.

Firstly, when finding optimal **Product Solutions**, that is in the evaluation and use of the best fastening part for the particular function intended in our customers' products.

Second, our **Assembly Technology Expert** services deliver the smartest solutions for all possible fastening challenges. Our services cover from the moment our customers developing a new product, to

assembly process optimization as well as fastening technology education for our customers' employees.

And thirdly, optimising our clients' productions in a smart and lean way with **Smart Factory Logistics**, our methodology, with intelligent logistics systems and tailor-made solutions.

Understood as a promise to our customers, "Proven Productivity" contains two elements: Firstly, that it demonstrably works. And secondly, that it sustainably and measurably improves the productivity and competitiveness of our customers.

And this for us is a philosophy which motivates us every day to always be one step ahead.

www.bossard.com