

Instruction Manual

Manuale istruzioni



CE

FastSetM12

HYDRO-PNEUMATIC TOOL FOR RIVET NUTS FROM M3 TO M12 WITH STROKE AND PRESSURE ADJUSTMENT

RIVETTATRICE OLEOPNEUMATICA PER INSERTI DA M3 A M12 CON REGOLAZIONE CORSA E PRESSIONE

STAMP OF THE AUTHORISED DEALER
TIMBRO DISTRIBUTORE AUTORIZZATO

WARNING!!!!

FASTSETM12 COMES WITHOUT KITS.

KITS HAVE TO BE ORDERED SEPARATELY ACCORDING TO THE USER NEEDS.

FEATURES

FASTSETM12 HAS BEEN DESIGNED AND TESTED TAKING INTO CONSIDERATION THE PROBLEMS OF OPERATORS SO THAT ASSISTANCE IS VERY REDUCED.

1. Air piston return (without spring);
2. Power piston air outwardly, not through the piston;
3. Kit assembly with toothed ring nut (wrench is no more necessary);
4. Tie rods are now replaced by commercial screws;
5. Additional unscrewing in case the user rivet nuts, unintentionally, an unsuitable insert, or in case it gets stuck due to an un-proper regulation.
6. One position trigger mechanism;
7. No adjustments are needed when there is a thickness change in materials;
8. No damages occurs to mandrel (or tie rod) if operations are repeated;
9. Lightweight;
10. Small dimensions;
11. Handiness.

FASTSETM12

WING PROTECTION (accessory on request)

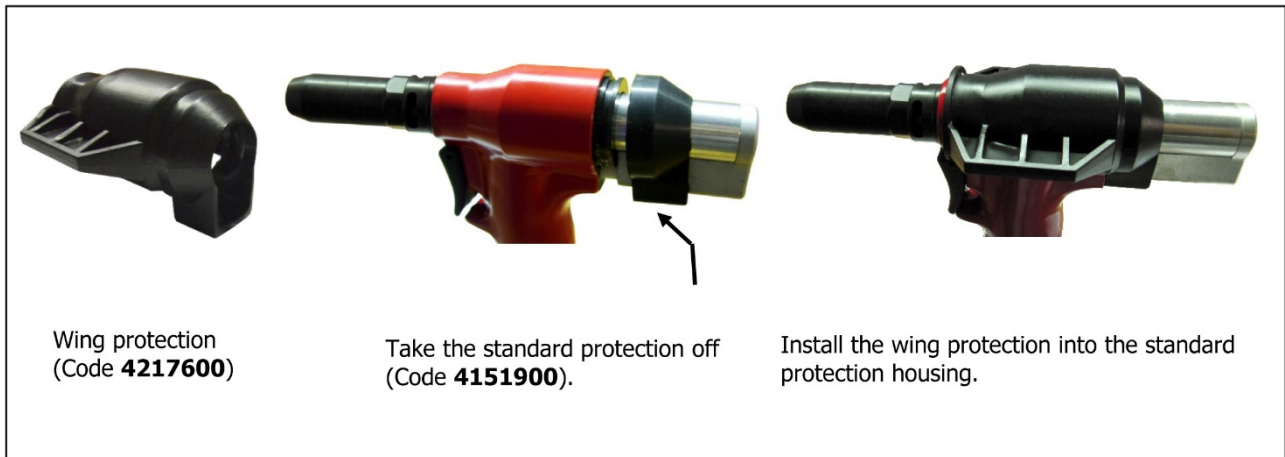

This wing protection (Code **4217600**) is designed to be used during the finishing of various works, when you must take extra care. Together with the rubber base, it creates a support for the tool, avoiding any contact of the surface with the metal part of the tool body.

The tool comes with PROTECTIVE COVER (11).

Remove the PROTECTIVE COVER (11) and
insert the PROTECTIVE COVER (Code
4147200).



Depending on the operating modes of the user, a PROTECTION COVER (Code 4147200) has been projected in order to make to tool quieter and with less air leakage. This particular item comes only on request.

ITEMS ON REQUEST

FASTSETM12

COMES WITH A SMOOTH BOTTOM (REF. A);
YOU CAN ORDER SEPARATELY THE BOTTOM +
THE MALE EYEBOLT (KIT REF. (B),
CODE 4540500)
+ THE BALANCER KG. 2/3 (CODE 0523200)

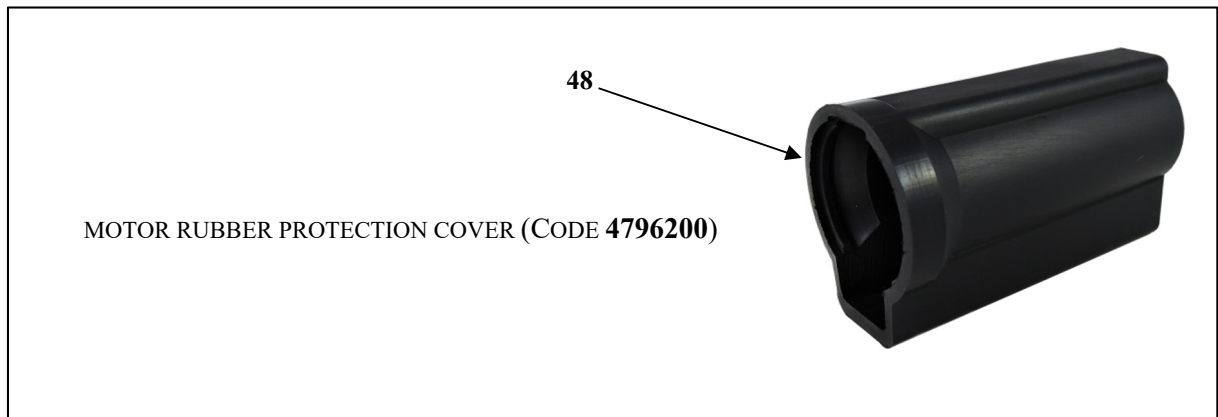
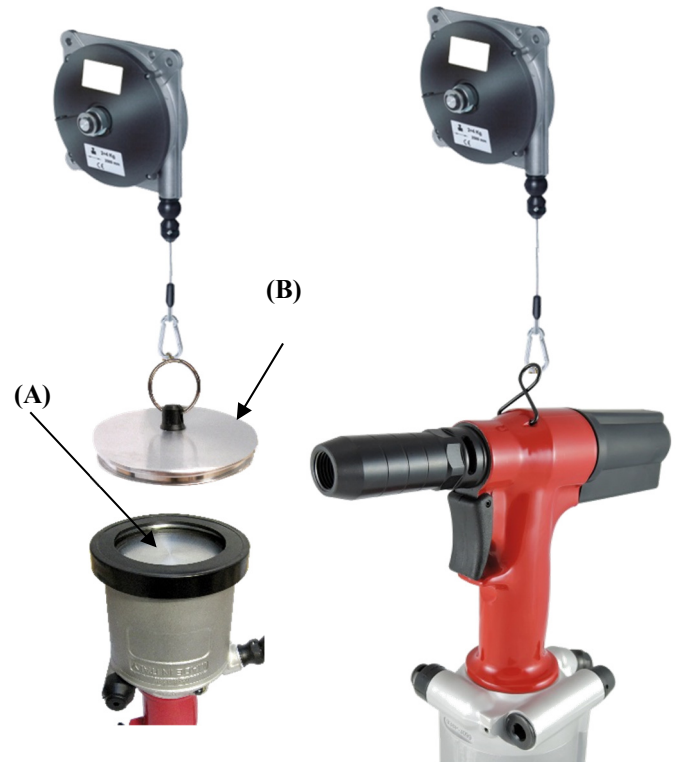

FASTSETM12 COMES WITHOUT THE ADJUSTABLE AIR SWITCH, WHICH IS AVAILABLE ON REQUEST (CODE 4280600).

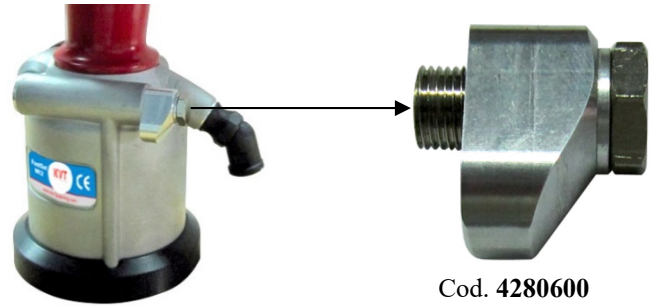

REF.	CODE	Q.TY	DESCRIPTION
Fig. 2.5 - A	4280600	1	COMPLETE ADJUSTABLE AIR SWITCH KIT 
1.	4280700	1	FILTER
2.	4280900	1	BLOCK
3.	3542800	1	SEAL WASHER
4.	4281100	1	SPECIAL HEXAGONAL HEAD SCREW

KIT 37 DEFLECTOR IS FITTED AS STANDARD ON THE TOOL; IF NECESSARY AN AIR ADJUSTABLE SPECIAL SWITCH IS AVAILABLE ON REQUEST (CODE 4280600).

CONTENTS

1 - GENERAL INFORMATION	PAGE 109	3.1.2 HIGH RESISTANCE SPECIAL KIT FOR M8 WITH FIXED RING NUT
1.1 ASSISTANCE		3.2 SPARE PARTS OF THE MOTOR UNIT (KIT 20)
1.2 CERTIFICATION AND EC MARKING		3.2.1 COMPLETE MOTOR KIT CONSISTING OF 5 ITEMS (CODE 4316600).
1.3 WARRANTY		3.3 ORDERING SPARE PARTS
1.4 MANUAL STRUCTURE		
1.4.1 PURPOSE AND CONTENTS		
1.4.2 RECEIVERS		
1.4.3 PLACING OF THE MANUAL		
1.4.4 SYMBOLS USED		
2 - TOOL DESCRIPTION	PAGE 111	4 - SAFETY
2.1 OPERATING SYSTEM		4.1 GENERAL WARNINGS
2.2 VIBRATION		4.2 INTENDED USE
2.3 NOISE LEVEL		4.3 OPERATING CONTAININDICATIONS
2.4 TECHNICAL DATA		4.4 RESIDUE RISKS
2.5 NOSE ASSEMBLIES AND STANDARD ACCESSORIES		4.5 IDENTIFICATION/SERIAL NUMBER
2.5.1 ACCESSORIES ON REQUEST		
2.5.1.1 FOR THREADED RIVET NUTS PLACING		5 - INSTALLATION
2.5.1.1.1 KIT FOR THREADED RIVET NUTS M3		5.1 TRANSPORT AND HANDLING
2.5.1.1.1.1 COMPOSITION KIT M3		5.2 STORAGE
2.5.1.1.2 KIT FOR THREADED RIVET NUTS M4		5.3 CONNECTIONS
2.5.1.1.2.1 COMPOSITION KIT M4		5.3.1 PNEUMATIC
2.5.1.1.3 KIT FOR THREADED RIVET NUTS M5		5.4 AIR SUPPLY
2.5.1.1.3.1 COMPOSITION KIT M5		5.5 PRELIMINARY CHECKS
2.5.1.1.4 KIT FOR THREADED RIVET NUTS M6		
2.5.1.1.4.1 COMPOSITION KIT M6		6 - OPERATION
2.5.1.1.5 KIT FOR THREADED RIVET NUTS M8		6.1 OPERATORS
2.5.1.1.5.1 COMPOSITION KIT M8		6.2 TOOL PREPARATION AND SCREW REPLACEMENT
2.5.1.1.6 KIT FOR THREADED RIVET NUTS M10		6.3 INFORMATON
2.5.1.1.6.1 COMPOSITION KIT M10		
2.5.1.1.7 KIT FOR THREADED RIVET NUTS M12		7 - SERVICING THE TOOL
2.5.1.1.7.1 COMPOSITION KIT M12		7.1 MAINTENANCE STATUS
2.5.1.1.8 AMERICAN UNC (INCHES) FLAT HEAD WITH BUSH 1/2-13UNC		7.2 CLEANING
2.5.1.1.8.1 COMPOSITION KIT 1/2-13UNC		7.3 ORDINARY MAINTENANCE
2.5.1.2 FOR MALE RIVET NUTS PLACING		7.3.1 FILLING THE HYDRAULIC CIRCUIT WITH OIL
2.5.1.2.1 KIT FOR MALE RIVET NUTS M4		7.3.2 /PARTS SUBJECT TO WEAR
2.5.1.2.1.1 COMPOSITION KIT M4		7.4 MAINTENANCE KIT ON REQUEST
2.5.1.2.2 KIT FOR MALE RIVET NUTS M5		
2.5.1.2.2.1 COMPOSITION KIT M5		8 - FAULT DIAGNOSIS
2.5.1.2.3 KIT FOR MALE RIVET NUTS M6		8.1 POSSIBLE FAULTS
2.5.1.2.3.1 COMPOSITION KIT M6		
2.5.1.2.4 KIT FOR MALE RIVET NUTS M8		9 - FAULT DIAGNOSIS AND REPAIRS
2.5.1.2.4.1 COMPOSITION KIT M8		9.1 REPAIRS
2.5.1.2.5 KIT FOR MALE RIVET NUTS M10		9.2 REQUESTING ASSISTANCE
2.5.1.2.5.1 COMPOSITION KIT M10		
2.5.1.3 HEAD EXTENSIONS		10 - DISMANTLING INSTRUCTIONS
		10.1 DISMANTLING INSTRUCTIONS
3 - SPARE PARTS	PAGE 130	11 - ENCLOSED DOCUMENTS
3.1 SPARE PARTS		11.1DECLARATION
3.1.1 QUICK KIT COMPLETE WITH SPRING		
3.1.1.1 QUICK KIT COMPLETE WITH SPRING COMPOSITION		
3.1.1.1.1 SPECIAL TOOTHED RING NUT FOR SOCKET CAP SCREWM8.NO NEED FOR REDUCTION (CODE 3472600) (OPTIONAL)		

1 - GENERAL INFORMATION

1.1 - ASSISTANCE

In case you need any assistance concerning the use and the maintenance of the tool, or in case you need to order any spare parts, you shall contact your local authorised dealer (or KVT - FASTENING directly) specifying the identification/serial numbers of the tool, written on its outer casing:

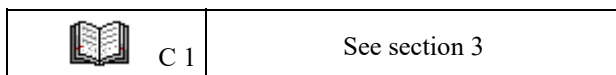

1.2 - CERTIFICATION AND EC MARKING

The tool is manufactured in compliance with the European Directives, which are in force when the tool itself is put on the market.

As the tool is not included in ENCLOSURE IV of DIRECTIVE 2006/42/EC, KVT - FASTENING issues a self-certification to apply the EC marking.

1.3 - WARRANTY

The warranty has a validity of 12 months, as of the date indicated on the invoice.

The warranty only covers replaced parts; labour is not included.

The following are not covered by warranty: standard accessories (see section 2.5) and tool damages caused by:

- transport and/or handling,
- user's mistakes,
- failed servicing/maintenance, as indicated in section 7 of this manual,
- faults and/or breakages that are not attributable to tool anomalies,
- normal consumption of consumables.

The warranty is invalidated both in case of unauthorised tampering/replacements of tool components and in case of use of accessories, tools or consumables different to those recommended by the manufacturer, which could even cause injuries to the tool's user.

1.4 - MANUAL STRUCTURE

This instruction manual must be read with particular attention by the Customer, as the correct pre-arrangement, installation and use of the tool, are the correct basis for a good relationship between Manufacturer and Customer.

1.4.1 - PURPOSE AND CONTENTS

The manual herein has the purpose of providing the Customer with all the information needed not only to use the tool correctly, but also to manage it self-sufficiently and safely. It includes information concerning technical aspects, operation, maintenance, spare parts and safety.

Users and Qualified Technicians must read the instructions given herein thoroughly before starting to use the tool.

If you have any doubts on the meaning of the instructions given, please do not hesitate to contact KVT - FASTENING for further explanations.

1.4.2 - RECEIVERS

The manual herein has been written for both the operators and the technicians enabled to service the tool.



Operators must not carry out procedures reserved to service and/or qualified technicians.

KVT - FASTENING is not liable for any damage deriving from the failed observance of this rule.

1.4.3 - PLACING OF THE MANUAL

This instruction manual must be kept near the tool, inside a dedicated container and, above all, away from liquids or anything else that may compromise its legibility.

1.4.4 - SYMBOLS USED

SYMBOL	MEANING	COMMENT
 P ...	HAZARD	This highlights a hazard with risk for the user.
 A ...	WARNING	This points out a warning/note on key functions or useful information. Read the texts indicated by this symbol with utmost attention.
 C ...	CONSULT	Consult the instruction manual before carrying out a specific procedure.

2 - DESCRIZIONE MACCHINA

TOOL DESCRIPTION

2.1 - OPERATING SYSTEM

The hydro-pneumatic FASTSETM12 tool, with oil pressure adjustment, is designed to place the following fasteners:

- Threaded female rivet nuts (from M3 to M12)
- Male rivet nuts (from M4 to M10)

The hydro-pneumatic system and the mechanical components used in the inside structure of the FASTSETM12, when compared with other riveting tools, result to be much more reliable. A tool feature is a reduction of the problems caused by the wear and tear of the components, and consequently the tool will last much longer and work better. The technical solutions adopted make the FASTSETM12 more compact and lighter: the result is a very handy tool.

2.2 - VIBRATION

When used correctly, i.e. in compliance with the instructions given, the tool does not produce any dangerous vibration.

2.3 - NOISE LEVEL

The tool is designed and manufactured in such a way that the noise level results to be very low. The weighed equivalent continuous acoustic pressure level A in the operator position is indeed below 80 dB (A).

The information given can, in any event, allow the tool user to better evaluate the possible and eventual risks of danger.

2.4 - TECHNICAL DATA

The following table provides the technical data and features of the tool, to which you must refer when contacting the Technical Assistance Department of KVT - FASTENING.

TABLE 2.4 A - TECHNICAL DATA AND FEATURES

AIR WORKING PRESSURE	6 bar
MIN – MAX AIR PRESSURE	5 – 7 bar
AIR CONSUMPTION PER CYCLE AT 6 BAR	5 litri
MAX STROKE	6,5 mm
MAX FORCE	26.600 N
MOTOR SPEED (SCREWING)	2200 rpm a 6,5 bar
MOTOR SPEED (UNSCREWING CYCL)	1750 rpm a 6,5 bar
DIRECT UNSCREWING SPEED	1850 rpm a 6,5 bar
WEIGHT (WITHOUT KIT)	2,200 Kg
VIBRATIONS	< 2,5 m/s ²
NOISE LEVEL	76 dB (A)

Figure 2.4 – B

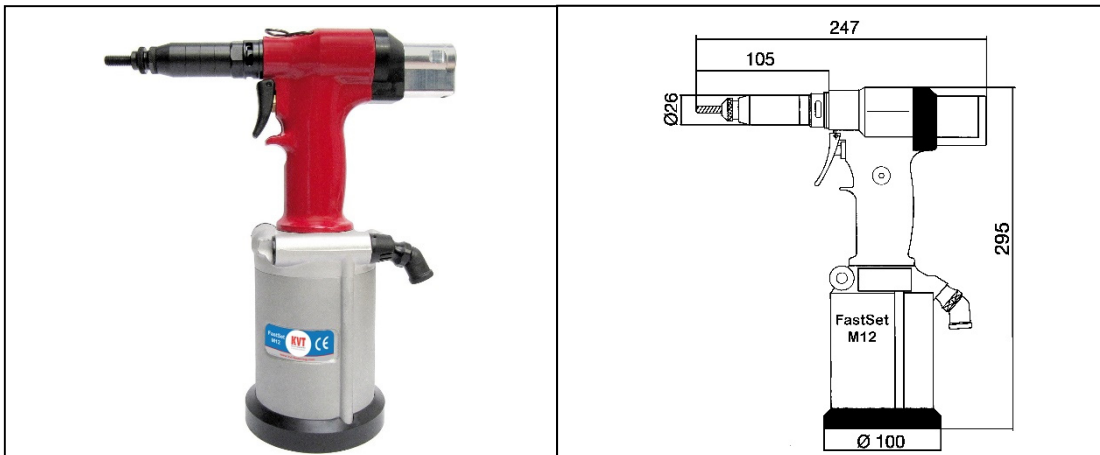
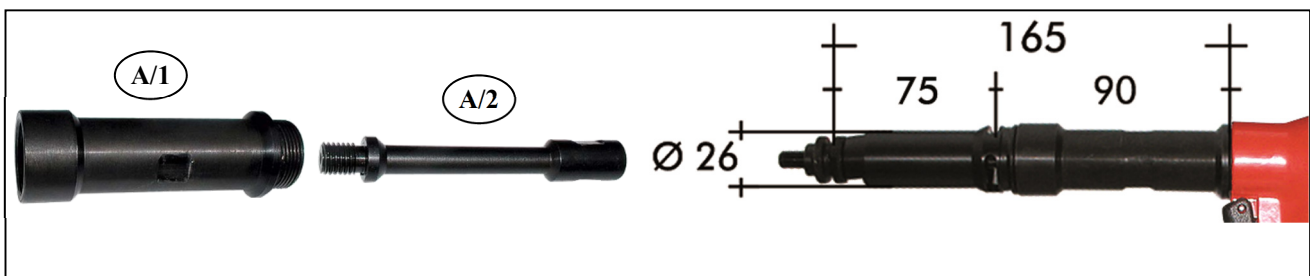

Figure 2.4 – C



REF.	CODE	Q.TY	DESCRIPTION
Fig. 2.4 - C	3531800	1	SPECIAL EXTENDED HEAD
A/1.	3446600	1	90 MM EXTENDED SLEEVE
A/2.	3446900	1	90 MM INTERNAL EXTENDED SLEEVE

Ordering the above two items, you can reach a total extension of the head of 165 mm (see figure 2.4-C)

2.5 - NOSE ASSEMBLIES AND STANDARD ACCESSORIES

The nose assemblies stated hereafter refers to standard tools.
Any special tool could consequently require special parts, different to those listed.

Figure 2.5 – A

REF.	CODE	Q.TY	DESCRIPTION	FASTSETM12- HYDRO-PNEUMATIC TOOL FOR RIVET NUTS WITH OIL PRESSURE ADJUSTMENT (FORCE)
Fig.2.5-A	4621500	1	FASTSETM12-HYDRO-PNEUMATIC TOOL FOR RIVET NUTS (IN CASE)	
50.	3064400	1	HYDRAULIC OIL TYPE ISO VG 32 100CC	
51.	0369800	1	PLASTIC CASE	
52.	0207300	1	UNIVERSAL KEY	
53.	2533800	1	EMERGENCY AND STROKE REGULATION PIN	
54.	4154200	1	REGULATION WRENCH MM. 3,0	
-	-	1	INSTRUCTION MANUAL	

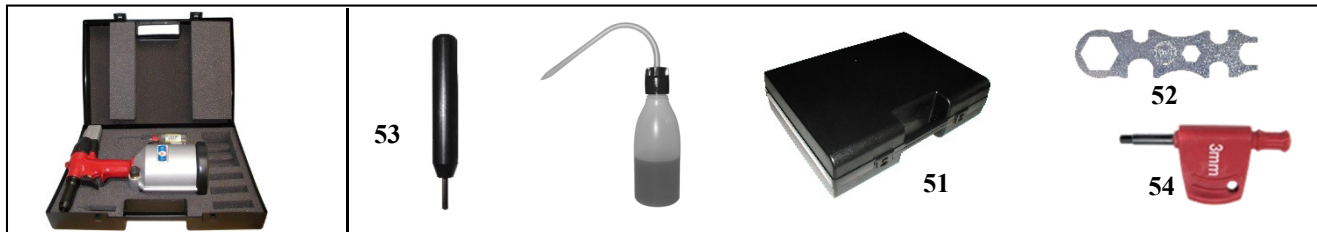

2.5.1 - ACCESSORIES ON REQUEST

The tool can be supplied with different accessories, according to the kind of fastener to be placed.

2.5.1.1 - FOR THREADED RIVET NUTS PLACING

	KIT	CODE
	M3	3441100
	M4	3441200
	M5	3441300
	M6	3441400
	M8	3441500
	M10	3441600
	M12	3441700
	1/2-13 UNC	4361600

You have to screw the different kits in this position

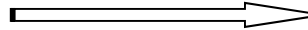

The user has to buy the following kits separately, choosing the correct one according to the fastener to be used.

<p>A 1</p>	<p>It is possible to order the head RING NUT separately (Code 0327700).</p>	
<p>A 2</p>		
<p>COMPLETE SPECIAL HEAD Ø 20,0, M8 (Code 4281000). We can supply, upon request, the head in different diameters and holes according to your needs.</p>		

2.5.1.1.1 KIT FOR THREADED RIVET NUTS M3

Figure 2.5 - B



REF.	CODE	Q.TY	DESCRIPTION
Fig. 2.5 - B	3441100	1	KIT FOR THREADED RIVET NUTS M3

2.5.1.1.1.1 KIT FOR THREADED RIVET NUTS M3 COMPOSITION

Figure 2.5 - C



TABLE 2.5 - A

REF.	CODE	Q.TY	DESCRIPTION
1.	3457500	1	HEAD WITH RING NUT FOR M3 SCREW
2.	3457400	1	ADAPTER FOR M3 SCREW
3.	3457600	1	SOCKET CAP SCREW M3x4012.9 UNI5931/DIN912
4.	3466200	1	HEXAGONAL JOINT WITH SPRING FOR M3 SCREW

On request we can provide the screw longer than the standard one.

REF.	CODE	Q.TY	DESCRIPTION
3a.	2193500	1	SOCKET CAP SCREW M3x50 12.9 UNI5931/DIN912 

2.5.1.1.2 KIT FOR THREADED RIVET NUTS M4

Figure 2.5 - D



REF.	CODE	Q.TY	DESCRIPTION
Fig. 2.5 - D	3441200	1	KIT FOR THREADED RIVET NUTS M4

2.5.1.1.2.1 KIT FOR THREADED RIVET NUTS M4 COMPOSITION

Figure 2.5 - E

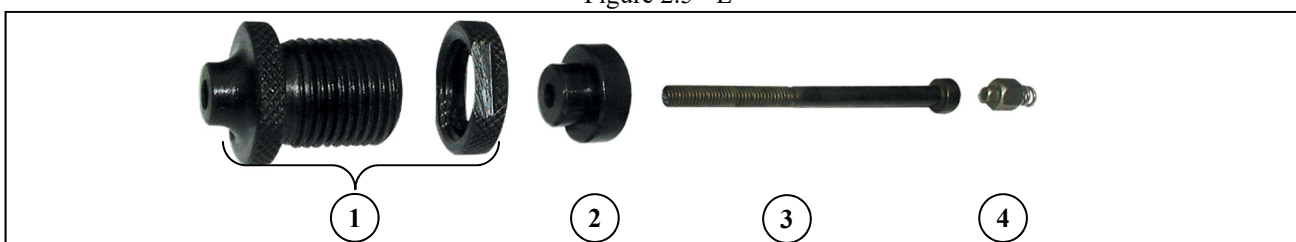



TABLE 2.5 - B

REF.	CODE	Q.TY	DESCRIPTION
1.	3470200	1	HEAD WITH RING NUT FOR M4 SCREW
2.	3466300	1	ADAPTER FOR M4 SCREW
3.	3470500	1	SOCKET CAP SCREW M4x5512.9 UNI5931/DIN912
4.	3470600	1	HEXAGONAL JOINT WITH SPRING FOR M4 SCREW

On request we can provide the screw longer than the standard one.

REF.	CODE	Q.TY	DESCRIPTION
3a.	4186400	1	SOCKET CAP SCREW M4x65 12.9 UNI5931/DIN912



2.5.1.1.3 KIT FOR THREADED RIVET NUTS M5

Figure 2.5 - F



REF.	CODE	Q.TY	DESCRIPTION
Fig. 2.5 - F	3441300	1	KIT FOR THREADED RIVET NUTS M5

2.5.1.1.3.1 KIT FOR THREADED RIVET NUTS M5 COMPOSITION

Figure 2.5 - G

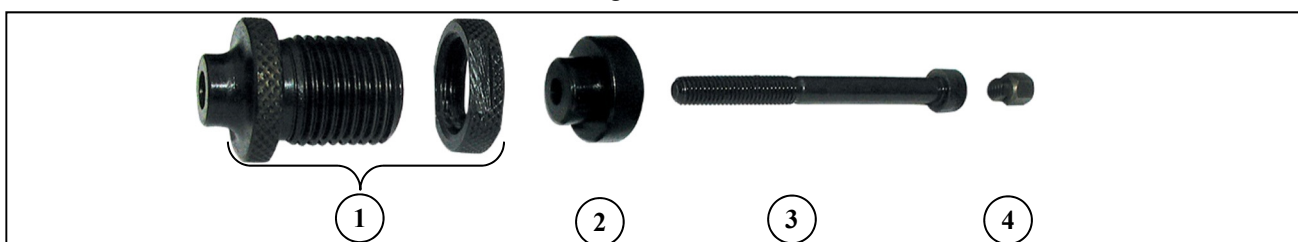

TABLE 2.5 - C

REF.	CODE	Q.TY	DESCRIPTION
1.	3471800	1	HEAD WITH RING NUT FOR M5 SCREW
2.	3471700	1	ADAPTER FOR M5 SCREW
3.	3471900	1	SOCKET CAP SCREW M5x55 12.9 UNI5931/DIN912
4.	3472000	1	HEXAGONAL JOINT FOR M5 SCREW

On request we can provide the screw longer than the standard one.

REF.	CODE	Q.TY	DESCRIPTION
3a.	4285500	1	SOCKET CAP SCREW M5x 65 12.9 UNI5931/DIN912



2.5.1.1.4 KIT FOR THREADED RIVET NUTS M6

Figure 2.5 - H



REF.	CODE	Q.TY	DESCRIPTION
Fig. 2.5 - H	3441400	1	KIT FOR THREADED RIVET NUTS M6

2.5.1.1.4.1 KIT FOR THREADED RIVET NUTS M6 COMPOSITION

Figure 2.5 - I

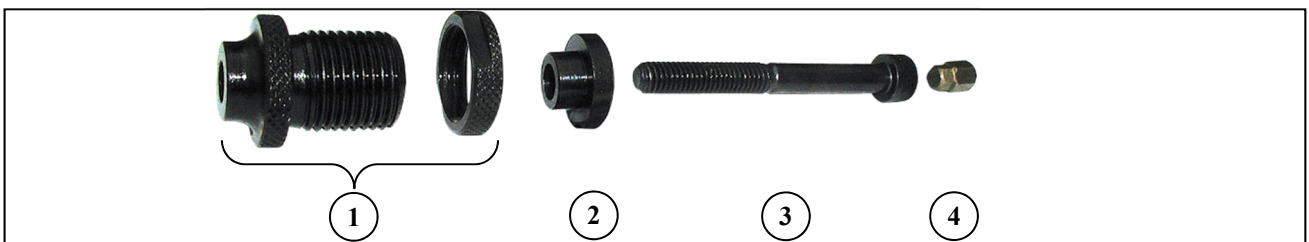



TABLE 2.5 - D

REF.	CODE	Q.TY	DESCRIPTION
1.	3472200	1	HEAD WITH RING NUT FOR M6 SCREW
2.	3472100	1	ADAPTER FOR M6 SCREW
3.	3472300	1	SOCKET CAP SCREW M6x5512.9 UNI5931/DIN912
4.	3472500	1	HEXAGONAL JOINT FOR M6 SCREW

On request we can provide the screw longer than the standard one.

REF.	CODE	Q.TY	DESCRIPTION
3a.	4285300	1	SOCKET CAP SCREW M6x65 12.9 UNI5931/DIN912



2.5.1.1.5 KIT FOR THREADED RIVET NUTS M8

Figure 2.5 - J



REF.	CODE	Q.TY	DESCRIPTION
Fig. 2.5 - J	3441500	1	KIT FOR THREADED RIVET NUTS M8

2.5.1.1.5.1 KIT FOR THREADED RIVET NUTS M8 COMPOSITION

Figure 2.5 - K

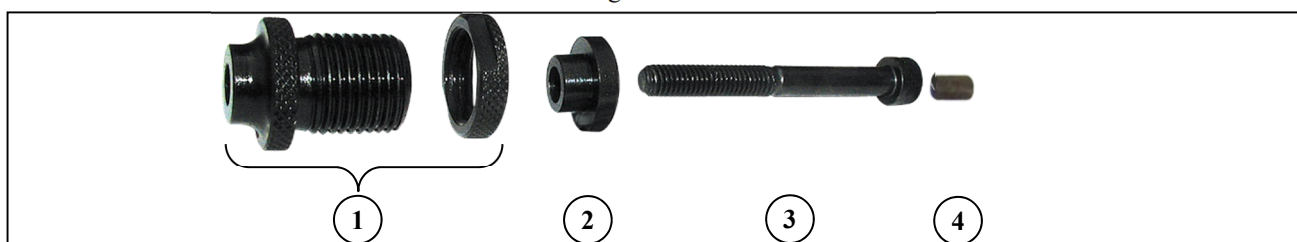

TABLE 2.5 - E

REF.	CODE	Q.TY	DESCRIPTION
1.	3472700	1	HEAD WITH RING NUT FOR M8 SCREW
2.	3472600	1	ADAPTER FOR M8 SCREW
3.	3472800	1	SOCKET CAP SCREW M8x6012.9 UNI5931/DIN912
4.	3472900	1	HEXAGONAL JOINT FOR M8 SCREW

On request we can provide the screw longer than the standard one.

REF.	CODE	Q.TY	DESCRIPTION
3a.	2192800	1	SOCKET CAP SCREW M8x65 12.9 UNI5931/DIN912



2.5.1.1.6 KIT FOR THREADED RIVET NUTS M10

Figure 2.5 - N



REF.	CODE	Q.TY	DESCRIPTION
Fig. 2.5 - N	3441600	1	KIT FOR THREADED RIVET NUTS M10

2.5.1.1.6.1 KIT FOR THREADED RIVET NUTS M10 COMPOSITION

Figura 2.5 – O/ Figure 2.5 - O

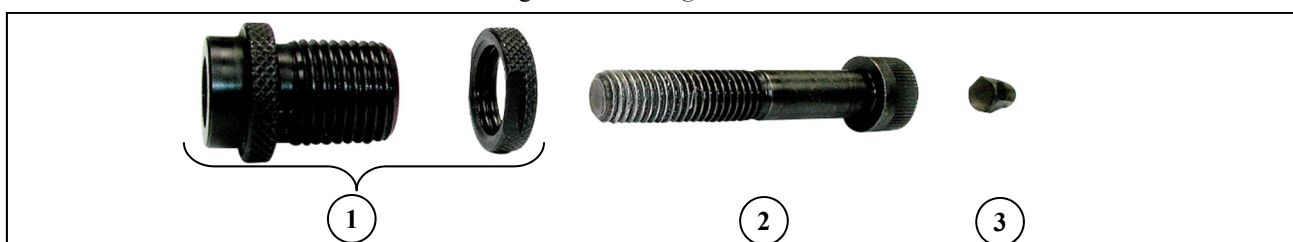

TABLE 2.5 - G

REF.	CODE	Q.TY	DESCRIPTION
1.	0329000	1	HEAD WITH RING NUT FOR M10 SCREW
2.	3473100	1	SOCKET CAP SCREW M10x6012.9 UNI5931/DIN912
3.	3441800	1	HEXAGONAL JOINT FOR M10 SCREW

On request we can provide the screw longer than the standard one.

REF.	CODE	Q.TY	DESCRIPTION
2a.	2428500	1	SOCKET CAP SCREW M10x70 12.9 UNI5931/DIN912
2b.	4180100	1	SOCKET CAP SCREW M10x1,25x60 12.9 UNI5931/DIN912

2.5.1.1.7 KIT FOR THREADED RIVET NUTS M12

Figure 2.5 - P



REF.	CODE	Q.TY	DESCRIPTION
Fig. 2.5 - P	3441700	1	KIT FOR THREADED RIVET NUTS M12

2.5.1.1.7.1 KIT FOR THREADED RIVET NUTS M12 COMPOSITION

Figure 2.5 - Q

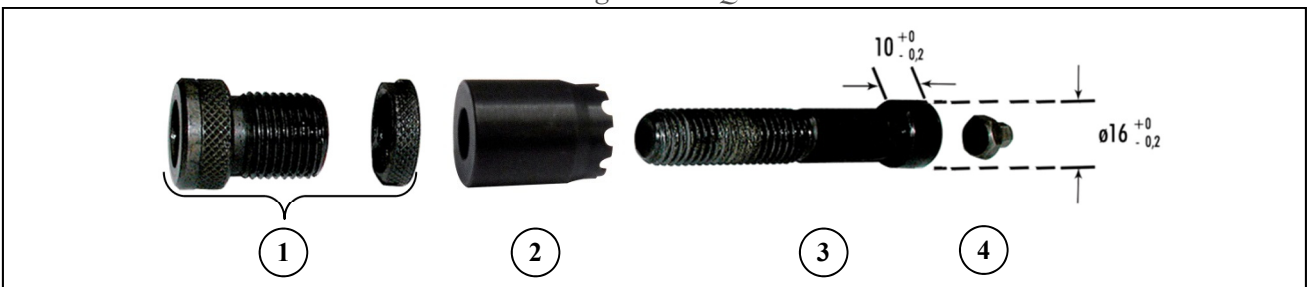

TABLE 2.5 - H

REF.	CODE	Q.TY	DESCRIPTION
1.	0329100	1	HEAD WITH RING NUT FOR M12 SCREW
2.	4316200	1	TOOTHED BLOCKING RING NUT
3.	3473300	1	M12X60 SOCKET CAP SCREW 12.9 (NOT STANDARD)
4.	3473400	1	HEXAGONAL JOINT FOR M12 SCREW

Socket cap screw (commercial allen spanner to be shaped; please refer to figure 2.5-Q).

2.5.1.1.8 AMERICAN UNC (INCHES) FLAT HEAD WITH BUSH

Figure 2.5 - R



REF.	CODE	Q.TY	DESCRIPTION
Fig. 2.5 - R	4361600	1	KIT 1/2-13UNC-AMERICAN UNC (INCHES) FLAT HEAD WITH BUSH



2.5.1.1.8.1 KIT FOR THREADED RIVET NUTS 1/2-13UNC COMPOSITION

Figure 2.5 - S



TABLE 2.5 - I

REF.	CODE	Q.TY	DESCRIPTION
1.	4378400	1	M8X6 SOCKET CAP SCREW NUT 4MM ALLEN KEY
2.	4378500	1	M8 - 1/2-13 UNC DOUBLE THREAD BUSH
3.	4378600	1	HEAD (HOLE Ø 8.1)
4.	3472600	1	ADAPTER (HOLE Ø 8.1)
5.	4187000	1	M8X70 SOCKET HEAD CAP SCREW 8.8, UNI 5931
6.	3472900	1	HEXAGONAL JOINT FOR M8 SCREW

 A 3	<p>KIT ASSEMBLY:</p> <p>1-Loosen the M8 nut (1). 2-Unscrew the bush (2). 3-Insert the screw (5) inside the ring nut supplied with the tool (Code 4172400). 4-Make sure that the nut (1) is tightly screwed.</p>	
--	---	---

2.5.1.2 - FOR MALE RIVET NUTS PLACING

	KIT	CODE
	M4	3442300
	M5	3442400
	M6	3442500
	M8	3422600

You have to screw the different kits in this position

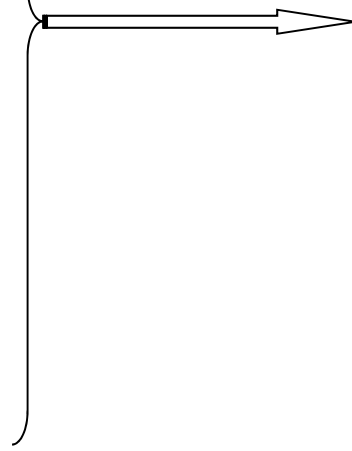



	M10	4601900
---	-----	---------

To install this kit you must first remove the quick-kit with spring

The user has to buy the following kits separately, choosing the correct one according to the fastener to be used.



The tool can have different kinds of head assemblies.

	<p>A 4</p>	<p>It is possible to order the head RING NUT separately (Code 0327700).</p>	
---	------------	--	---

2.5.1.2.1 KIT FOR MALE RIVET NUTS M4

Figure 2.5 - T



REF.	CODE	Q.TY	DESCRIPTION
Fig. 2.5 - T	3442300	1	KIT FOR MALE RIVET NUTS M4

2.5.1.2.1.1 KIT FORM MALE RIVET NUTS M4 COMPOSITION

Figure 2.5 - U



TABELLA 2.5 - J
TABLE 2.5 - J

REF.	CODE	Q.TY	DESCRIPTION
1.	2561200	1	HEAD WITH RING NUT FOR MALE RIVET NUTS M4
2.	3441900	1	TIE ROD FOR MALE RIVET NUTS M4
3.	3441800	1	HEXAGONAL JOINT FOR M4 SOCKET CAP SCREW MALE RIVET NUTS

2.5.1.2.2 KIT FOR MALE RIVET NUTS M5

Figure 2.5 - V

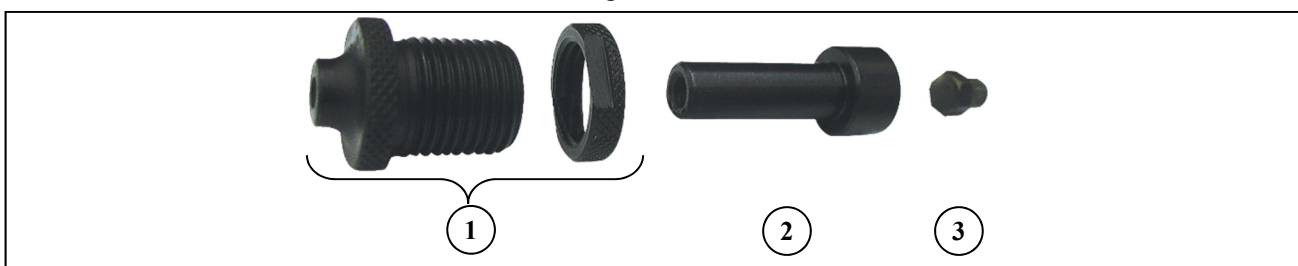

REF.	CODE	Q.TY	DESCRIPTION
Fig. 2.5 - V	3442400	1	KIT FOR MALE RIVET NUTS M5

2.5.1.2.2.1 KIT FORM MALE RIVET NUTS M5COMPOSITION

Figure 2.5 - W

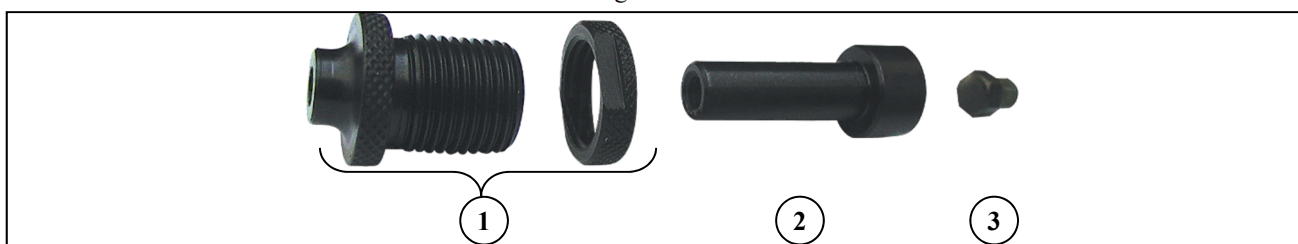
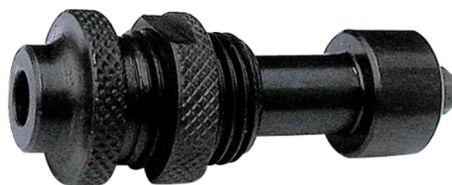

TABLE 2.5 - K

REF.	CODE	Q.TY	DESCRIPTION
1.	2561300	1	HEAD WITH RING NUT FOR MALE RIVET NUTS M5
2.	3442000	1	TIE ROD FOR MALE RIVET NUTS M5
3.	3441800	1	HEXAGONAL JOINT FOR M5 SOCKET CAP SCREW MALE RIVET NUTS

2.5.1.2.3 KIT FOR MALE RIVET NUTS M6

Figure 2.5 - X



REF.	CODE	Q.TY	DESCRIPTION
Fig. 2.5 - X	3442500	1	KIT FOR MALE RIVET NUTS M6

2.5.1.2.3.1 KIT FORM MALE RIVET NUTS M6COMPOSITION

Figure 2.5 - Y

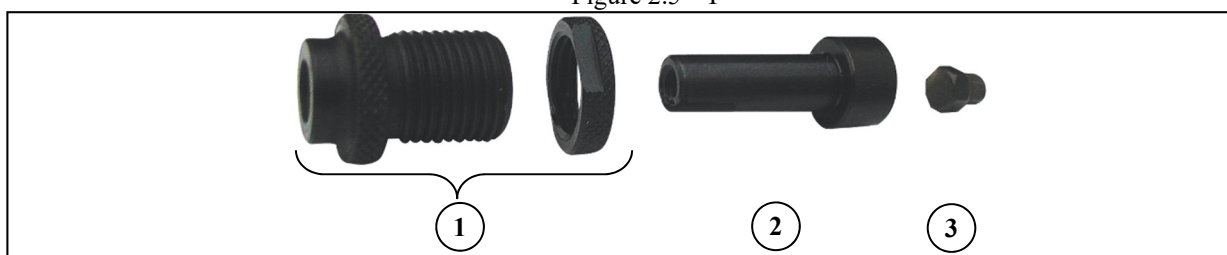

TABLE 2.5 - L

REF.	CODE	Q.TY	DESCRIPTION
1.	2561400	1	HEAD WITH RING NUT FOR MALE RIVET NUTS M6
2.	3442100	1	TIE ROD FOR MALE RIVET NUTS M6
3.	3441800	1	HEXAGONAL JOINT FOR M6 SOCKET CAP SCREW MALE RIVET NUTS

2.5.1.2.4 KIT FOR MALE RIVET NUTS M8

Figure 2.5 - Z



REF	CODE	Q.TY	DESCRIPTION
Fig. 2.5 - Z	3442600	1	KIT FOR MALE RIVET NUTS M8

2.5.1.2.4.1 KIT FORM MALE RIVET NUTS M8COMPOSITION

Figure 2.5 - AA



TABLE 2.5 - M

REF.	CODE	Q.TY	DESCRIPTION
1.	2700500	1	HEAD WITH RING NUT FOR MALE RIVET NUTS M8
2.	4316200	1	TOOTHED BLOCKING RING NUT
3.	3442200	1	TIE ROD FOR MALE RIVET NUTS M8
4.	3441800	1	HEXAGONAL JOINT FOR M8 SOCKET CAP SCREW MALE RIVET NUTS

2.5.1.2.5 KIT FOR MALE RIVET NUTS M10

Figure 2.5 - AB



REF.	CODE	Q.TY	DESCRIPTION
Fig. 2.5 - AB	4601900	1	KIT FOR MALE RIVET NUTS M10

2.5.1.2.5.1 KIT FORM MALE RIVET NUTS M10 COMPOSITION

Figure 2.5 - AC

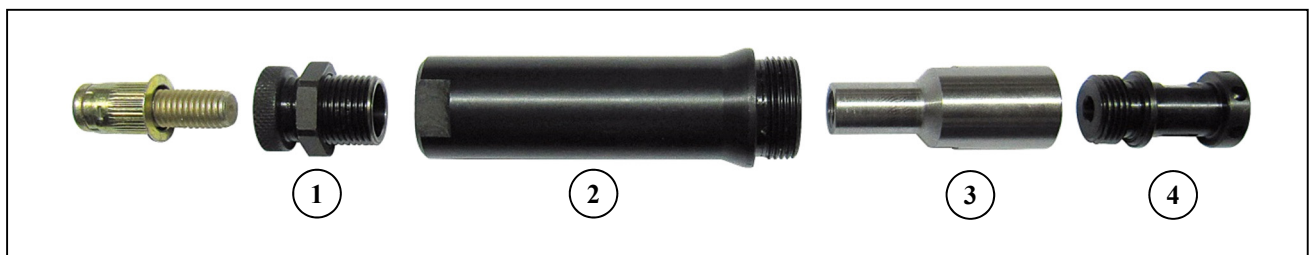
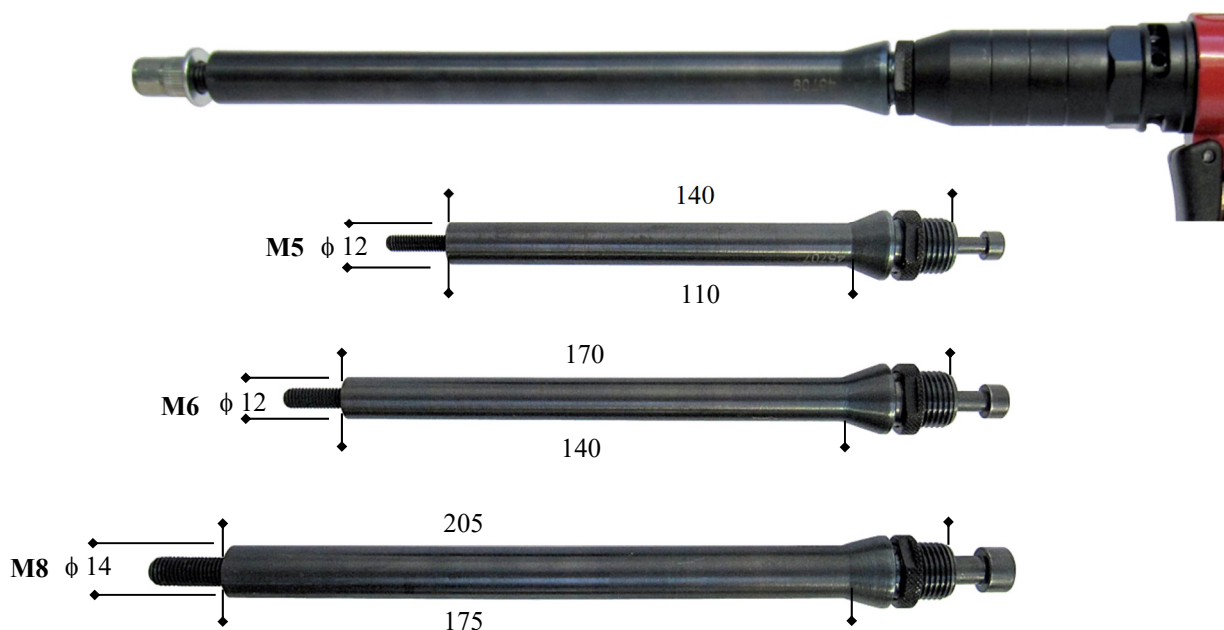

TABLE 2.5 - N

REF.	CODE	Q.TY	DESCRIPTION
1.	4601700	1	HEAD WITH RING NUT FOR MALE RIVET NUTS ø 10
2.	4601600	1	EXTERNAL SLEEVE
3.	4601800	1	FEMALE TIE ROD FOR MALE RIVET NUTS M10
4.	3540100	1	TIE ROD CONNECTOR WITH O-RING

2.5.1.3 - HEAD EXTENSIONS



The total length of the extension is obtained using the HEAD EXTENSION and the EXTERNAL SLEEVE on the Tool.

REF.	CODE	Q.TY	DESCRIPTION
Kit 110/140	4572500	1	KIT-HEAD EXTENSION D.12x110/140MM FOR THREADED RIVET NUTS M5
	4570700	1	HEAD EXTENSION D.12x110/140 FOR THREADED RIVET NUTS M5
	45513GR	1	SOCKET CAP SCREW UNI5931/DIN912 PLAIN M5x170

REF.	CODE	Q.TY	DESCRIPTION
Kit 140/170	4572600	1	KIT-HEAD EXTENSION D.12x140/170MM FOR THREADED RIVET NUTS M6
	4570800	1	HEAD EXTENSION D.12x140/170 FOR THREADED RIVET NUTS M6
	45702GR	1	SOCKET CAP SCREW UNI5931/DIN912 PLAIN M6x200

REF.	CODE	Q.TY	DESCRIPTION
Kit 175/205	4572700	1	KIT-HEAD EXTENSION D.14x175/205MM FOR THREADED RIVET NUTS M8
	4570900	1	HEAD EXTENSION D.14x175/205 FOR THREADED RIVET NUTS M8
	45514GR	1	SOCKET CAP SCREW UNI5931/DIN912 PLAIN M8x240

It goes without saying that any modifications and/or additional accessories must be explicitly approved and manufactured by KVT - FASTENING.

3 - SPARE PARTS

3.1 - SPARE PARTS

Figure 3.1 - A - Spare parts

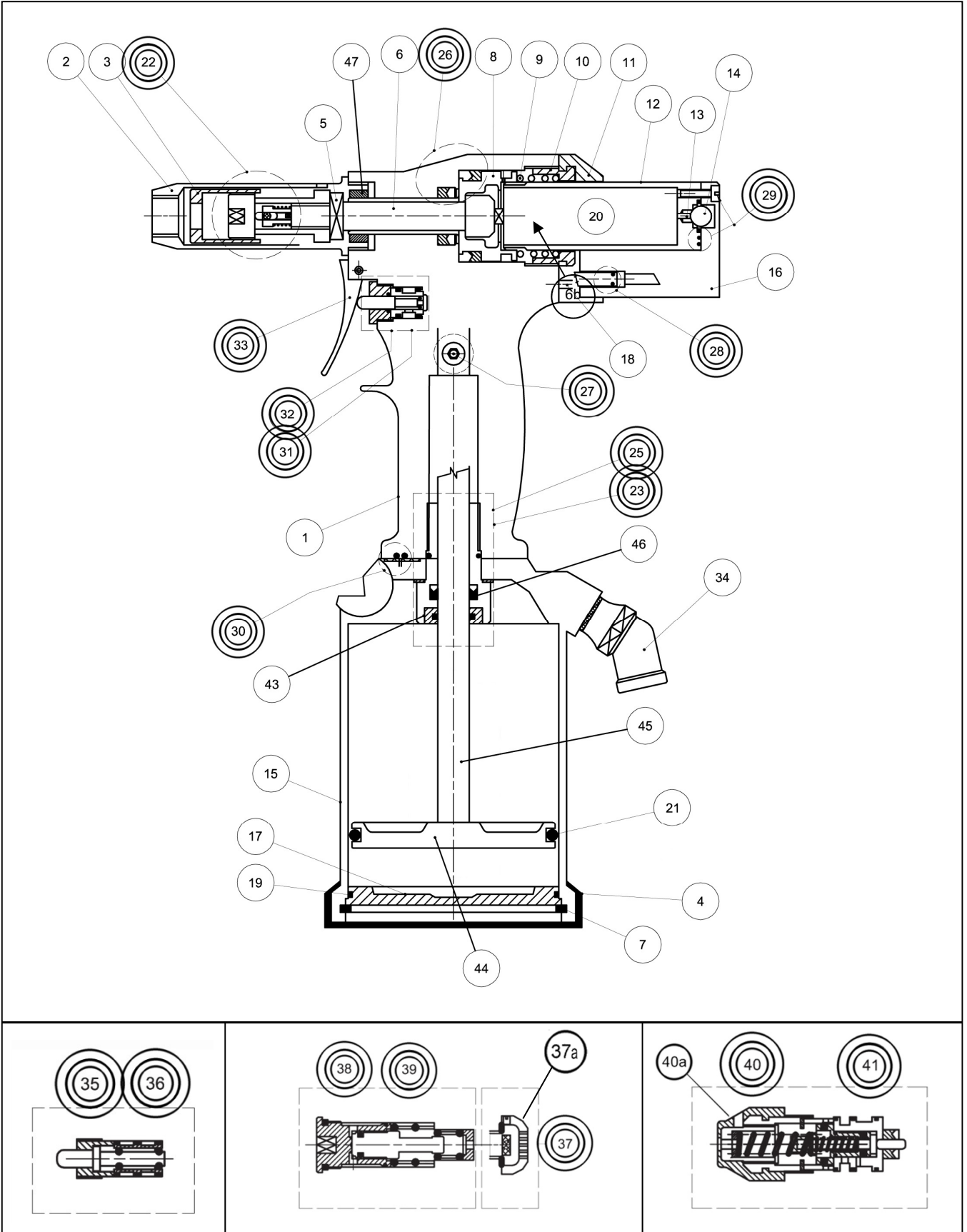

See Figures 3.1 – A

TABLE 3.1 - A

REF.	CODE	Q.TY	DESCRIPTION	REF.	CODE	Q.TY	DESCRIPTION
1.	4153100	1	HANDLE CASING	26.	4151000	1	PISTON GASKET KIT 2 PIECES 
2.	3539900	1	OUTER CONE 	27.	4175700	1	OIL CAP KIT WITH O-RING 
3.	4172400	1	TOOTHED BLOCKING RING NUT M3-M10	28.	4175600	1	AIR HOSES KIT WITH O-RING 6 PIECES 
4.	4165100	1	RUBBER BASE	29.	4151100	1	O-RING KIT + SCREWS 5 PIECES 
5.	4277200	1	RING NUT	30.	4152300	1	FLAT GASKET KIT + O-RING 
6.	4151500	1	ROTATING PIN + SKIMMER	31.	4151200	1	O-RING KIT 4 PIECES 
6b.	3097900	1	SKIMMER WASHER	32.	4156900	1	KIT COMPLETE WITH O-RING 7 PIECES 
7.	3093200	1	BOTTOM BLOCKING SNAP RING	33.	4153400	1	LEVER – PIN KIT 
8.	4151300	1	OIL PISTON	34.	3235500	1	SUPPLE AIR CONNECTION THREAD 1/4"+1/4" GAS + ALUMINIUM WASHER
9.	4151700	1	SPRING	35.	4157000	1	KIT COMPLETE WITH O-RING 8 PIECES 
10.	5167800	1	RING NUT	36.	4156600	1	O-RING KIT 5 PIECES 
11.	4151900	1	PROTECTIVE COVER	37.	4291600	1	BAFFLE KIT 3 PIECES 
12.	3761500	1	MOTOR CASING	37a.	4412900	1	DEFLECTOR
13.	3761300	1	ROD	38.	4155800	1	O-RING KIT 7 PIECES 
14.	3096900	1	BALL	39.	4157100	1	KIT COMPLETE WITH O-RING 13 PIECES 
15.	4645300	1	AIR BODY	40.	4154400	1	GASKET KIT 7 PIECES 
16.	4152000	1	DISPENSER	40a.	4412100	1	MANOSTAT PROTECTIVE COVER
17.	3762300	1	BOTTOM	41.	4647900	1	KIT COMPLETE 18 PIECES 
18.	4152100	1	PIN	43.	4645600	1	RING NUT WITH LIP SEALS
19.	3762200	1	O-RING	44.	4645400	1	PISTON
20.	3761000	1	MOTOR UNIT	45.	4645500	1	STEM
21.	3235600	1	O-RING	46.	4645700	1	GASKET
22.	4174200	1	QUICK KIT WITH SPRING 	47.	5114200	1	STOP RING
23.	4647700	1	RING NUTS AND SEAL KIT 	48.	4796200	1	MOTOR RUBBER PROTECTION COVER 
25.	4647600	1	COMPLETE STEM GUIDE KIT 6 PIECES 	-	4316600		SEE KIT PAGE 133

3.1.1 - QUICK KIT COMPLETE WITH SPRING

Figure 3.1 – B



REF.	CODE	Q.TY	DESCRIPTION
Fig. 3.1 - B	4174200	1	QUICK KIT WITH SPRING

3.1.1.1 - QUICK KIT COMPLETE WITH SPRING COMPOSITION

Figure 3.1 - C

REF.	CODE	Q.TY	DESCRIPTION
A1	4172400	1	TOOTHED BLOCKING RING NUT M3-M10
A2	4176900	1	SCREW CONNECTION WITH SPRING

**3.1.1.1.1 SPECIAL TOOTHED RING NUT FOR SOCKET CAP SCREW M8
NO NEED FOR REDUCTION (CODE. 3472600) (OPTIONAL)**

Figure 3.1 – D

REF.	CODE	Q.TY	DESCRIPTION
Fig. 3.1 - E	4280300	1	SPECIAL TOOTHED RING NUT, HOLE \varnothing 8

3.1.2 - HIGH RESISTANCE SPECIAL KIT FOR M8 WITH FIXED RING NUT

This kit was made for those who need to use M8 rivet nuts only. The locking ring (Code **4508700**) is made with high resistance material, so that the head of the allen spanner does not press it down, and also keeps a constant tolerance and increased durability.

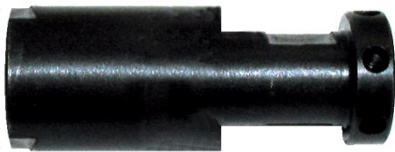

KIT Code 4508800

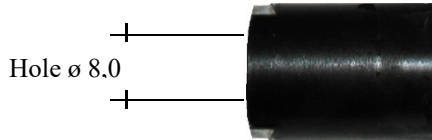

Code 4508700



Code 3540100

3.2 - SPARE PARTS OF THE MOTOR UNIT (KIT 20)

Figure 3.2 - A - Motor spare parts

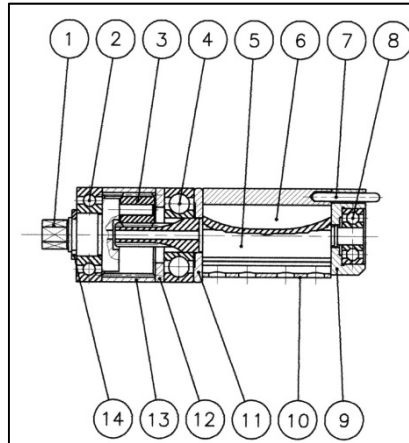

REF.	CODE	Q.TY	DESCRIPTION				
Fig. 3.2 - A	3761000	1	MOTOR UNIT (20)				
REF.	CODE	Q.TY	DESCRIPTION	REF.	CODE	Q.TY	DESCRIPTION
1.	3763400	1	PLANET WHEEL HOLDER	8.	3327300	1	BEARING
2.	3763300	1	BEARING	9.	3327400	1	REAR PLATE
3.	3763200	3	PLANET WHEEL	10.	3327000	1	STATOR
4.	3327500	1	BEARING	11.	3326900	1	FRONT PLATE
5.	3523400	1	ROTOR	12.	3763700	1	SPACER
6.	3327100	5	FIN	13.	3763600	1	CROWN WHEEL
7.	3327200	1	ROLLER	14.	3763500	1	SNAP RING

NOTE: When placing an order, please indicate always the REF. number and the DESCRIPTION.

3.2.1 - COMPLETE MOTOR KIT CONSISTING OF 5 ITEMS (Code 4316600)

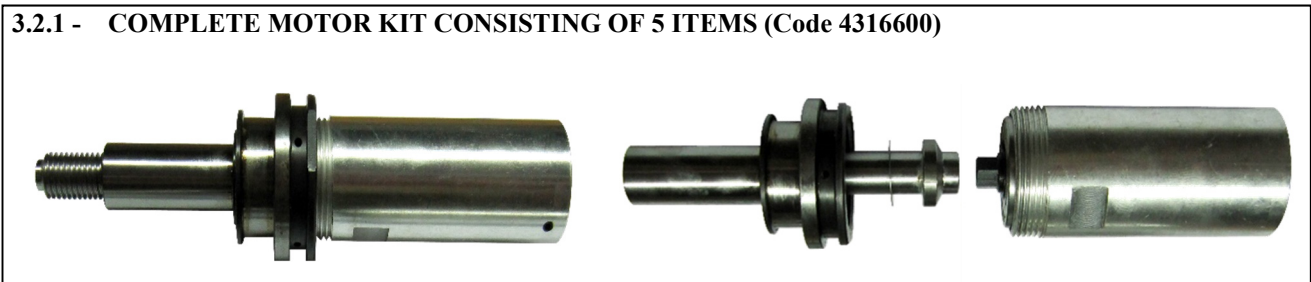

3.3 - ORDERING SPARE PARTS

Remember that only local authorised dealers are allowed to repair the tool. Failing this, you are requested to contact the Technical Assistance Service of KVT - FASTENING, where qualified engineers avail of the correct tools and original spare parts to solve any problems.

Follow the instructions given in section 1.2. to order the spare parts previously listed.

4 - SAFETY

4.1 - GENERAL WARNINGS

The operator must read carefully the information given in the present manual, especially with regard to the safety precautions listed in this chapter.

The operator must also observe the warnings listed below:

- The tool shall be used exclusively by trained personnel.
- The tool and the work area shall be kept clean and tidy.
- The tool shall be rested upright on the rubber base on a flat surface to prevent it from dropping.
- The tool shall only be used in normal psychophysical conditions.
- The user shall wear suitable clothing taking care to avoid entanglement of loose parts, ties, long hair, cleaning rags etc. in the tool itself.
- When using the tool, the wearing of safety glasses is required both by the operator and others in the vicinity to protect against fastener ejection. Besides we recommend wearing gloves when using the tool.
- The user shall use the accessories supplied and indicated in the 'servicing' chapter (see chapter 7) when servicing and/or adjusting the tool.
- The plates applied on the tool by KVT - FASTENING shall not be removed or altered.
- Unauthorised personnel shall not be allowed to touch the tool.
- Make sure that the air supply hoses are correctly sized for the use envisaged.
- Do not drag the tool holding it by the hose when it is connected to the power supply. Keep the hose away from sources of heat and from sharp objects.
- Remember to remove service or adjustment keys after having carried out repair and/or adjustment jobs.
- Before disconnecting the compressed air hose from the tool, ensure it is not pressurised.
- Tool repairs and cleaning jobs must be carried out with the tool disconnected from the power supply.
- When filling with oil, only use fluids with the characteristics indicated herein.
- If you should accidentally spill oil on your skin, rinse and wash thoroughly with water and alkaline soap.
- Where possible, you are recommended to use a safety balance to support the tool.
- Pay attention to possible risk of whiplash with the air supply hoses.
- Do not operate the tool when it is directed towards any person(s) or the operator.

4.2 - INTENDED USE

The tool is designed exclusively to be used with rivet nuts as described in section 2.1: female type with thread between M3 and M10, and male rivet nuts with thread between M4 and M10.

4.3 - OPERATING CONTRAINDICATIONS

The tool shall not be used:

- For purposes different to those listed in previous para 4.2.
- In explosive or aggressive atmosphere or when there is an excessive amount of dust or oil in the air.
- In atmosphere subject to the risk of fire.
- When it is exposed to weather conditions.

4.4 - RESIDUE RISKS

During the normal working cycle and when servicing the tool, the operators are exposed to some residue risks which, due to the nature of the operations to be carried out, cannot be totally eliminated.

- **Risk of breakage of the supply hose due to the fact that it contains compressed air. It is therefore absolutely crucial not to exceed the maximum pressure indicated in the technical data (see section 2.5).**

4.5 - IDENTIFICATION/SERIAL NUMBER



5 - INSTALLATION

5.1 - TRANSPORT AND HANDLING

The tool can be hand carried. You are recommended to store the tool in its case after using it. The tool can be transported safely if it has been correctly put away in its case.

 A 5	Damages to the tool caused during transport and/or handling are not covered by WARRANTY . Repairs or replacements of damaged parts are at Customer's charge.
---	--

5.2 - STORAGE

If you are not going to use the tool for a long time, you must put it away according to the following suggestions:

- Store the tool indoors.
- Protect the tool from impacts and stresses by keeping it in its case.
- Protect the tool from damp and excessive thermal excursions.
- Keep the tool away from corrosive substances.

5.3 - CONNECTIONS

To avoid all sorts of problems when starting the tool you are recommended to observe the following.

5.3.1 - PNEUMATIC

The pneumatic line is connected by mean of a quick-release coupling hose to be attached to the supple air connection, thread 1/4"+1/4" gas, supplied with the tool.

The air supply hose must be flexible and must meet the safety requirements of the pressurised products.

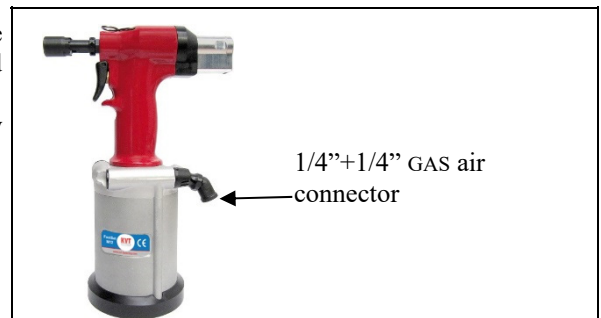

5.4 - AIR SUPPLY

The air supply line must be free from dirt and damp to prevent the early wear of the moving components of the tool. You are therefore recommended to use dry air: i.e. not greased.

5.5 - PRELIMINARY CHECKS

Before putting the tool into service you need to make a few inspections and checks in order to prevent errors or accidents while starting it.

- Check if the tool has been damaged during transport.
- Check if the compressed air hose is perfectly connected to the air supply line.
- Check if the tool turns freely and if the motor runs freely.

6 - OPERATION

6.1 - OPERATORS

The tool is designed to be used by one operator only.

Tool operators must satisfy the requirements stated hereafter (or they must be informed and trained accordingly). They must be aware of the manual herein and of all information relevant to safety:

- They must have some general and technical education, to a sufficient level to be able to understand the manual and to interpret the drawings and the diagrams correctly.
- They must be acquainted with the main hygienic rules, and with the industrial-safety and technological instructions.
- They must have an overall knowledge of the line and of the factory in which the tool is installed.
- They must know what to do in case of emergency, where to find the individual protection means and how to use them correctly.

Together with the above-mentioned requirements, the service technicians must also have an appropriate technical training.



P 1

MOTOR SCREWING

When the rotating pin (**6 Code 4151500**) is broken and you replace it, it may happen that the motor rotates continuously, which means that the shaft (**13 Code 3761300**) is too long; in this case it will have to be shortened by a few tenths to obtain the closure of the ball (**14 Code 3096900**). When the air is on, the shaft shall have no end float.

Unlike the situation above, the shaft is too short and it has to be replaced with a new one, fitting it without end float, with the air on, in order to obtain the closure of the ball (**14 Code 3096900**).

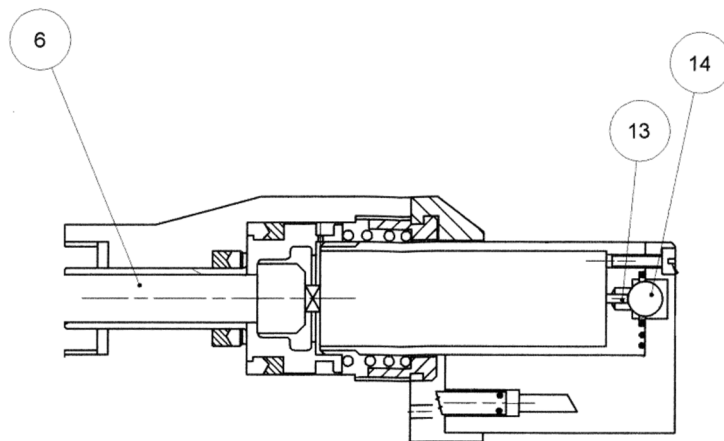

6.2 - TOOL PREPARATION AND SCREW REPLACEMENT

	<p>Warning: Tool setting and screw replacement must be carried out with the tool disconnected from the air supply line.</p>
P 2	

Figure 6.2 - A

Between the casing and the nut, there must be a distance of 1.5 mm for motor screwing.

To replace screws you have to carry out the following operations:
Unscrew the toothed ring 1 from the tool. Insert joint 2. Insert screw 3. Insert screw adapter 4. Screw the toothed ring 1 considering that the screw (or tie rod) must oscillate, then try and find the most suitable joint (see indented ring). Screw 5 and 6.

Figure 6.2 - B

TO UNSCREW THE KIT HOLDER QUICK RING

Press with two fingers the little pin, sliding it inside the hole and unscrew the ring simultaneously.

Figure 6.2 – C

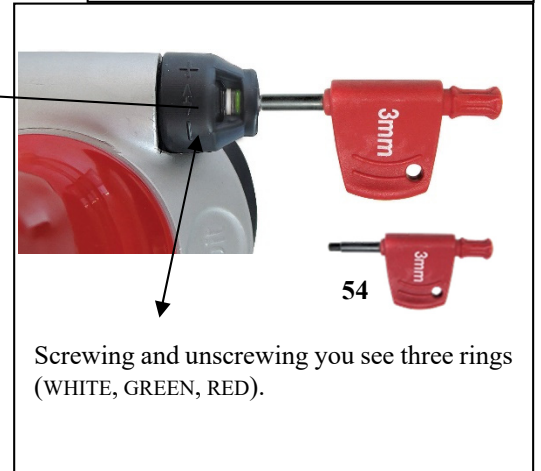
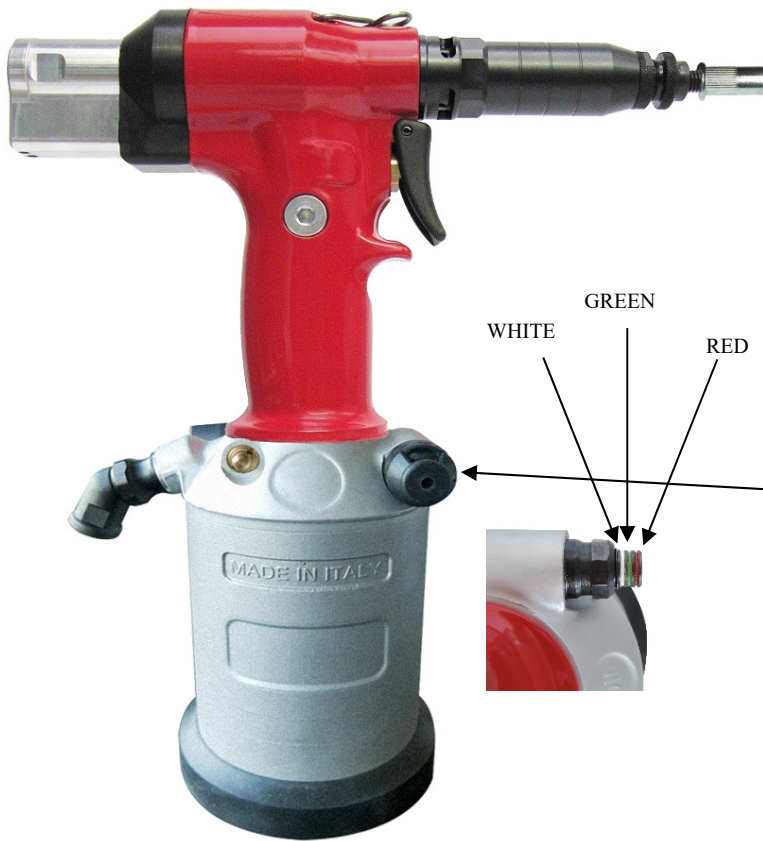

OIL (FORCE) PRESSURE ADJUSTMENT – SCREW THE INSERT

M3 WHITE

M4 }
M5 } GREEN

M6 }
M8 } RED
M10 }

Note: These settings are general guidelines to the operator. Rivet nuts are not uniform as hardness and therefore some modifications may be necessary (+ or -).

IMPORTANT

OIL (FORCE) PRESSURE ADJUSTMENT
Turning rightward, screwing the force increases.
Turning leftward, decreases.

WARNING

When the pressure (force) adjustment screw is entirely screwed, unscrewing can be done at a pressure not less than 6.5 bar (atm).

6.3 - INFORMATION

To be used in case the rivet nut gets stuck, or in case you decide that the inserted rivet nut is not the correct one and you have to change it.

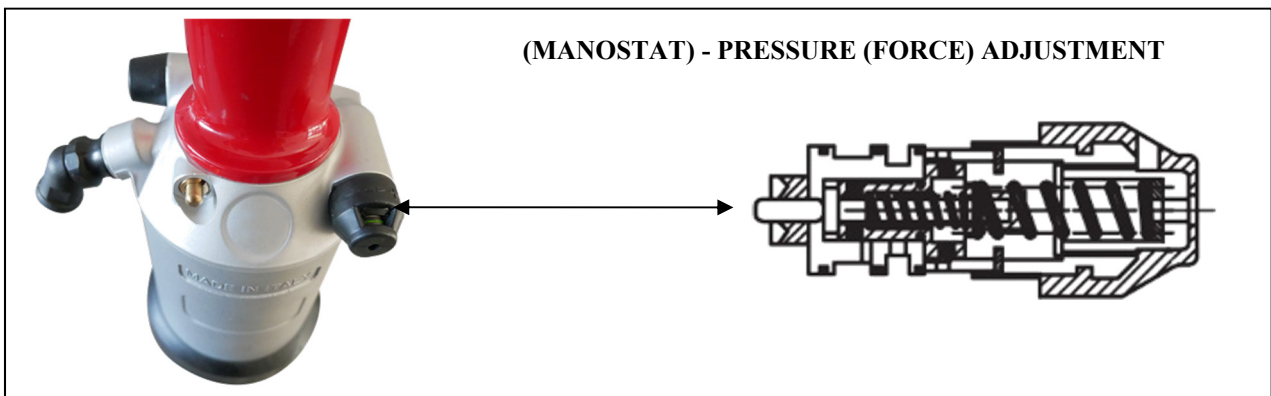
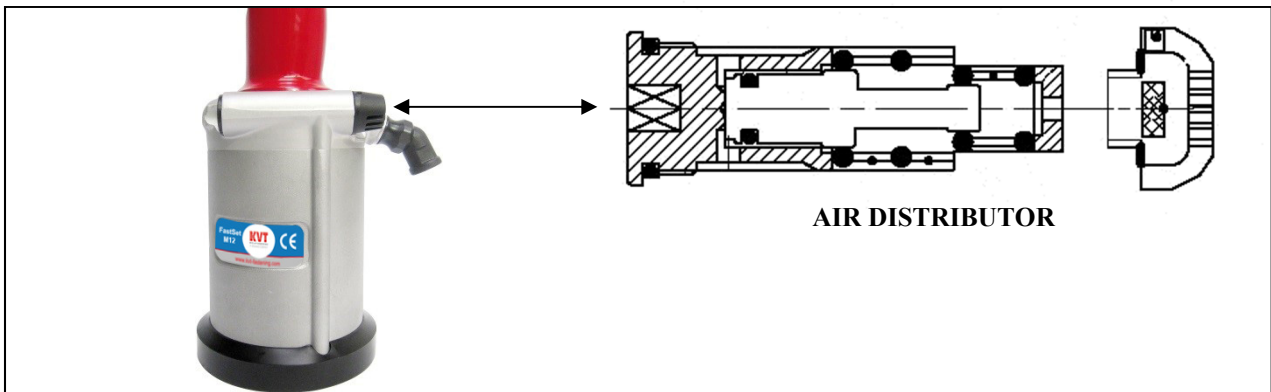
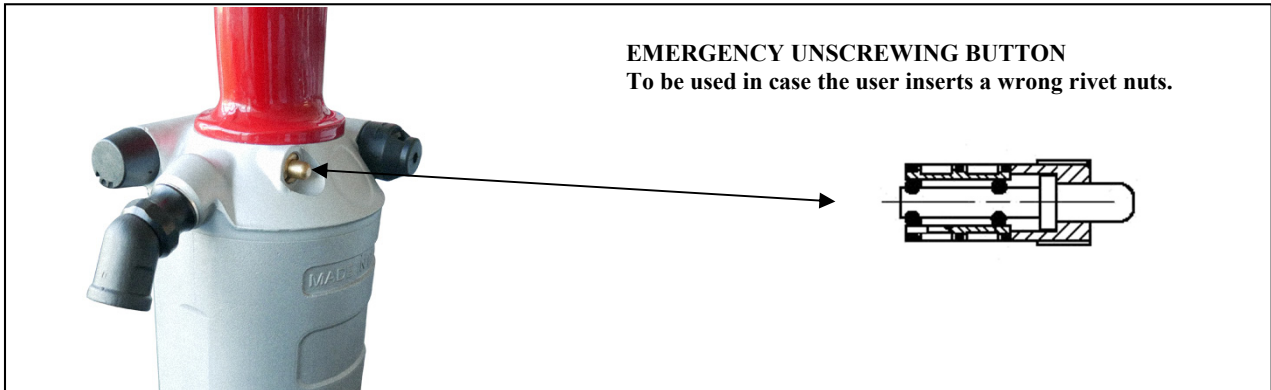

WARNING!!!

- 1- The cycle of unscrewing may not occur when the rivet nut is not mounted on the screw (tie trod); the manostat isn't under pressure
- 2- The not under pressure oil, does not allow the manostat to do the unscrewing.

Figure 6.3 – A

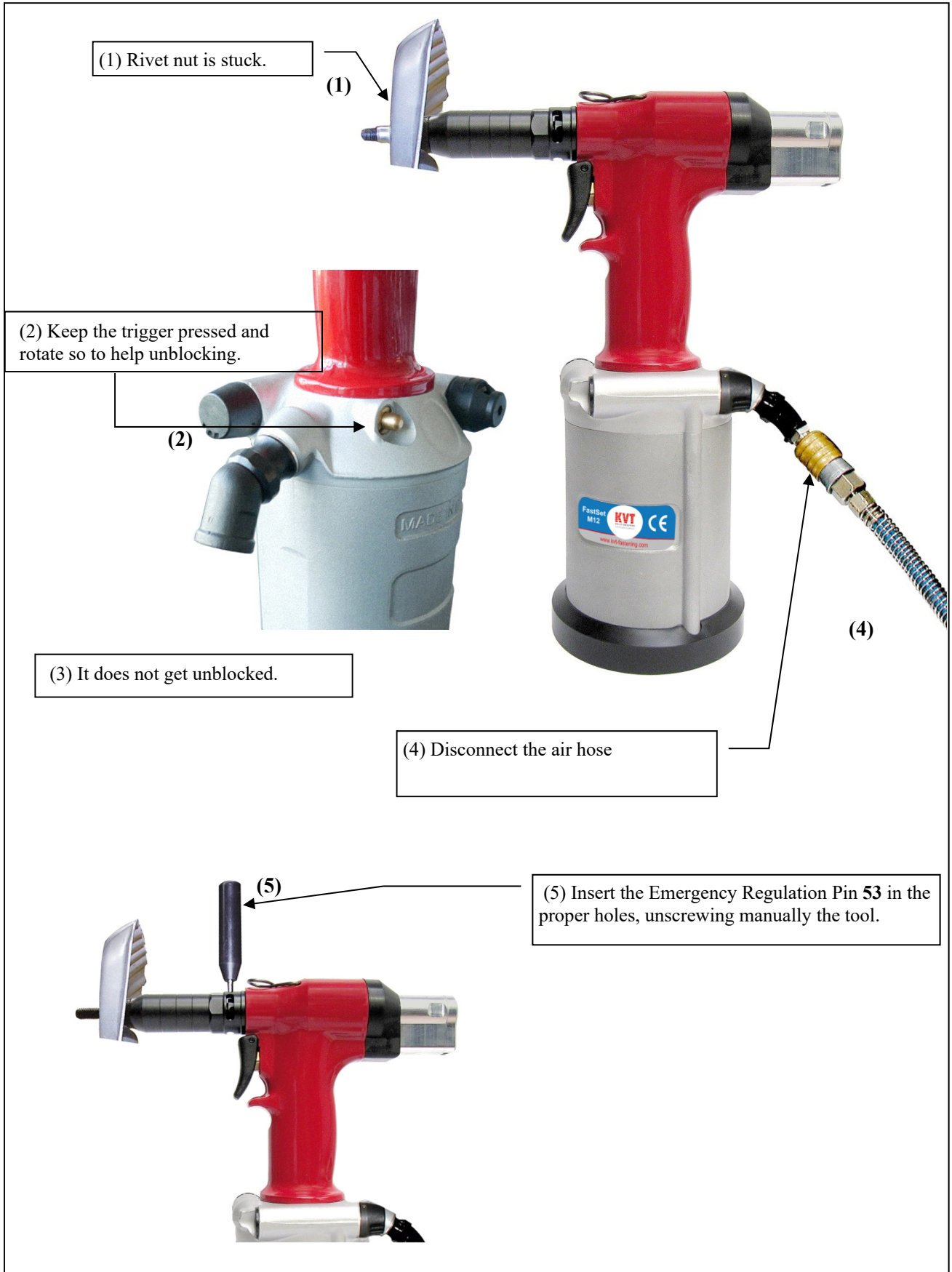

7 - SERVICING THE TOOL

7.1 - MAINTENANCE STATUS

Maintenance operations must be carried out with the tool stopped and disconnected from the pneumatic supply line.

Warnings:

- The tool maintenance instructions must be followed carefully.
- To ensure safety and perfect tool efficiency, you are recommended to use exclusively ORIGINAL spare parts.

7.2 - CLEANING

It is a good rule to completely clean and grease the tool on a periodic basis (depending on the type and frequency of use). Anyhow these operations must be carried out at least once a year.

 P 3	<p>Shut-off all sources of power to the tool. The operator must wear and use suitable personal protections before starting to clean the tool.</p>
--	--

7.3 - ORDINARY MAINTENANCE

See Figure 6.2 - A.

In order to prevent stoppages and faults of the tool, an ordinary maintenance (including inspections, checks and operations) must be scheduled to keep the following under systematic control:

- state of lubrication of the tool.
- state of wear of consumables.

7.3.1 - REFILLING THE HYDRAULIC CIRCUIT WITH OIL

Figure 7.3 – A

The hydraulic circuit needs to be refilled with oil after a continuous use, and when you notice a reduction in the tool stroke.

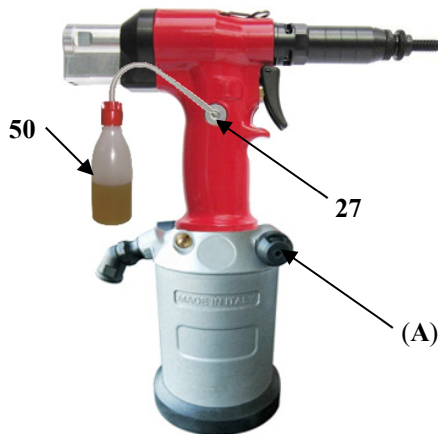

Proceed as follows (see Picture 7.3-A):

- Disconnect the airline from the tool inlet.
- Unscrew the manostat (A) with relevant wrench **54**;
- Remove cap together with relevant washer **27**.
- Put the tool in horizontal position and slowly pour in the hydraulic oil (ISO VG 32 type) **50** until the circuit is full.
- Screw cap back on, together with relevant washer **27**.
- Connect the tool to compressed air line and start up a couple of idle cycles. Stop pulling the trigger and slowly loosen screw **27**; make sure that the circuit is full with oil and that no air bubbles are left inside.

Wear gloves when managing the oil.

Do not throw the old oil outdoors but hand it over to an authorised waste disposal centre.

Warning!: if you should accidentally spill oil on your skin, wash and rinse thoroughly with water and alkaline soap.

7.3.2 - PARTS SUBJECT TO WEAR

On a periodic basis check the state of wear of the rubber base, as this is what ensures the stability of the tool. If it should need replacing, order the spare base from KVT - FASTENING indicating the year/serial number of the tool (see section 4.5).





On a periodic basis check the state of wear of the screws and of the heads and, if necessary, replace them as indicated in section 6.2.

Spare parts are to be ordered exclusively from KVT - FASTENING, specifying the codes listed in section 3.1.

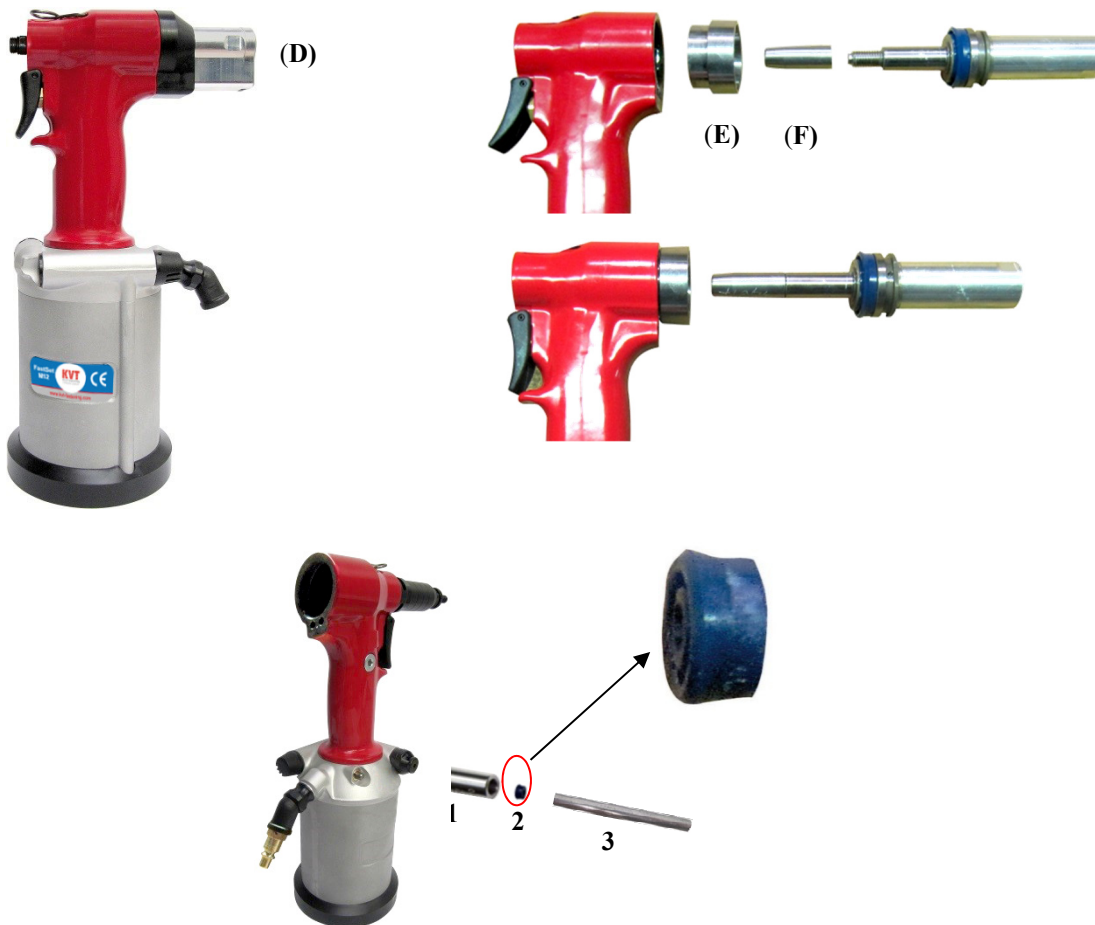
7.4 - MAINTENANCE KIT ON REQUEST



Follow the instructions below:



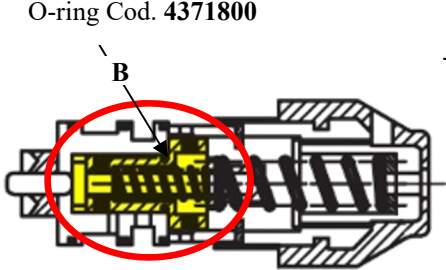
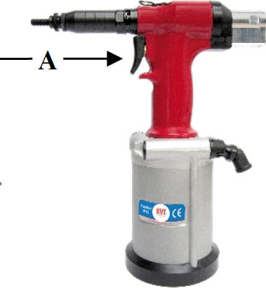
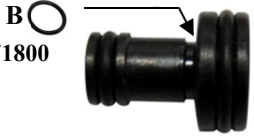

REF.	CODE	Q.TY	DESCRIPTION
D.	4461800	1	MILLED SLEEVE TO SCREW AND UNSCREW THE RING NUT (10) 
E.	4461900	1	BUSH FOR INTRODUCTION OF ROTATING PIN (6) FITTED WITH GASKET 
F.	4461700	1	THREAD PROTECTOR METAL FERRULE FOR INSERTION OF ROTATING PIN (6) to avoid damages to the gasket in the KIT (26) 
1.+ 3.	4380800	1	GUIDE BUSH + ALUMINIUM CYLINDRICAL PIN Ø 8X78  to insert ø 9 lip seal, located at the bottom of the manostat (ref. C)
2.	-	1	ø 9 LIP SEAL GASKET (REF. C) belonging to KIT (41) 

8 - FAULT DIAGNOSIS

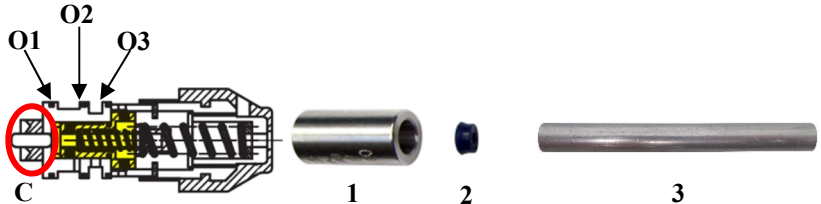
8.1 - POSSIBLE FAULTS

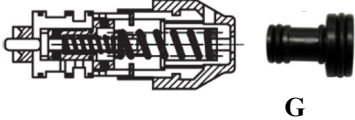
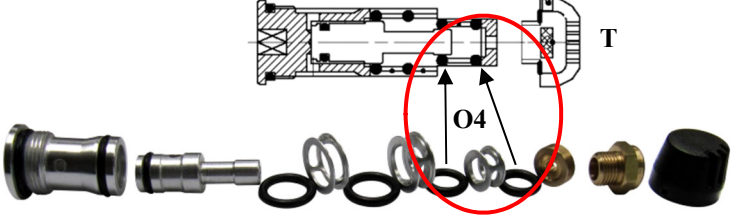
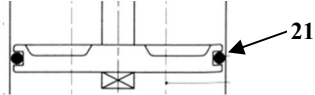
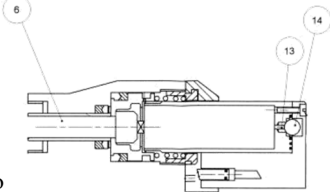
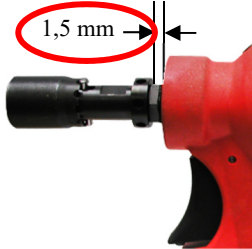
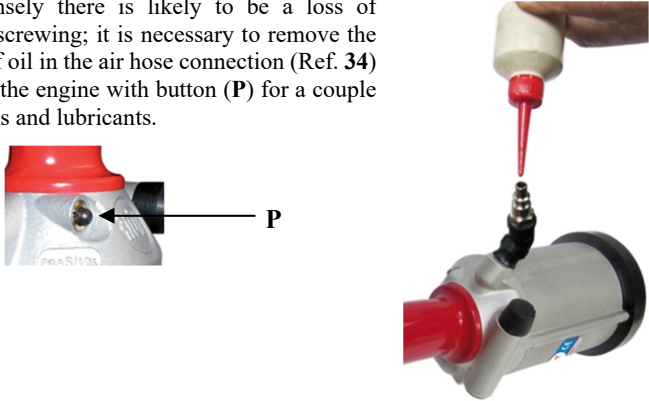
		
CAUSE	REMEDY	
<p>Traction is not correctly performer.</p>	<p>It lacks oil [see para. 7.3.1].</p>	
<p>Unscrewing is not correctly performed.</p>	<p>When inserting the rivet nut in the tie rod, after pressing the trigger (A), unscrewing is not correctly performed. Oil is not enough: add some.</p>	
<p>Unscrew without traction.</p>	<p>Or (B) broken: replace it.</p>	
<p>Slows the unscrewing after traction.</p>	<p>Working intensively it loses greasing and tends to harden. Remove the piston (G), and grease.</p>	
<p>Replacing parts of the manostat.</p>	 <p>When you have to work on the manostat:</p> <ol style="list-style-type: none"> 1. Remove air 2. Loosen the oil cap (27) to avoid the coming out of gasket (C). In case of replacement use guide (1), insert the gasket (2) and push it with the pin (3). If after reassembling of all parts of the pressure switch, it does not work properly, O-rings (O1, O2, O3) have not been correctly assembled: O-ring (O2), when broken unscrews without making traction O-ring (O3) makes traction but no unscrew O-ring (O1) can leak air Consequently it is advisable to replace all 3 O-rings (ORM 15x1) of the kit(ref.41) code 4157200. 	

CAUSE	REMEDY
<p>The transition time from stroke to unscrewing slows.</p>	<p>Open the manostat and pull the piston out (G), grease it and reassemble it.</p> 
<p>Air leaks from muffler (T).</p>	 <p>Check the two O-rings (O4) and O-ring (21 Code 3235600) which could be worn or broken.</p> 
<p>MOTOR screwing</p>	<p>- When the rotating pin (6 Code 4151500) is broken and you replace it, it may happen that the motor rotates continuously, which means that the shaft (13 Code 3761300) is too long; in this case it will have to be shortened by a few tenths to obtain the closure of the ball (14 Code 3096900).</p> <p>- Unlike the situation above, the shaft is too short and it has to be replaced with a new one, fitting it without end float, with the air on, in order to obtain the closure of the ball (14 Code 3096900).</p> 
<p>Quick kit assembly.</p>	<p>When assembling the quick kit (code 4176900), with air, make sure to create an axial space of 1.5mm between the lock nut and the end of the piston.</p> 
<p>Loss of revolution or stopping during unscrewing.</p>	<p>When you are working intensely there is likely to be a loss of revolutions or a stop when unscrewing; it is necessary to remove the air hose and add a few drops of oil in the air hose connection (Ref. 34) and re-enter the air by turning the engine with button (P) for a couple of minutes, so the engine cleans and lubricants.</p> 
<p>Air leaks from air distributor.</p>	<p>In case of loss of air from the air distributor, the plate of the piston is broken.</p> 

9 - FAULT DIAGNOSIS AND REPAIRS

9.1 - REPAIRS

To ensure the operational efficiency and safety of the tool, all repair jobs shall be carried out exclusively by the local authorised dealer or by the Technical Assistance Service of KVT - FASTENING (see section 1.2).

9.2 - REQUESTING ASSISTANCE

For any information concerning Use, Maintenance, Installation, Repair and so on, KVT - FASTENING is at the Customer's full disposal for all enquiries.

When making enquiries the customer is requested to be absolutely clear and to make always reference to this Manual and, in particular, to the instructions given in section 1.2.

10 -DISMANTLING INSTRUCTIONS

10.1 - DISMANTLING INSTRUCTIONS

When demolishing the tool you need to separate the plastic parts, which are to be disposed of in compliance with current Regulations.

As for the bulk metal part of the tool, simply split-up the steel parts from those in other metals or alloys and send to be melted down and recycled.

The oil drained from the tool must not be thrown outdoors but handed over to an authorised spent oil disposal centre.

11 -ENCLOSED DOCUMENTS

11.1 - DECLARATION

The following declaration is enclosed:

- Declaration of Conformity to DIRECTIVE 2006/42/EC.

DECLARATION OF CONFORMITY

DECLARE

in the person of:

Thomas Kraus haer
(Managing Director)

under our sole responsibility that the tool

FASTSETM12

Serial n°: _____

to which this declaration relates is:

IN CONFORMITY

with the provisions of the Machine Directive 2006/42/CE

Technical documentation at::

**KVT-Fastening
Zweigniederlassung der Bossard AG Lagerstrasse 8
CH-8953 Dietikon / Zürich**

Date 19.11.19

Signature

ATTENZIONE!!!!

LA FASTSETM12 VIENE FORNITA SENZA KIT.

SONO DA CHIEDERE A PARTE SECONDO LE ESIGENZE DELL'UTILIZZATORE.

CARATTERISTICHE

L'ATTREZZO MODELLO FASTSETM12 È STATO ANALIZZATO E PROGETTATO TENENDO CONTO DELLE PROBLEMATICHE DEGLI OPERATORI IN MODO CHE L'ASSISTENZA SIA MOLTO LIMITATA.

1. Ritorno pistone pneumatico aria (senza molla);
2. Alimentazione pistone aria all'esterno non attraverso il pistone;
3. Montaggio kit con ghiera dentata (non si usa più la chiave);
4. Tiranti sono delle viti commerciali;
5. Svitamento supplementare sia nel caso in cui l'operatore involontariamente inserisce un inserto non adatto o una male regolazione in cui rimane bloccato;
6. Pulsante unica fase;
7. Non occorre nessuna regolazione al variare dello spessore;
8. Nessun danno al mandrino o tirante, se l'operazione viene ripetuta;
9. Peso contenuto;
10. Ingombro ridotto;
11. Maneggevolezza.

FASTSETM12

PROTEZIONE ALARE (accessorio a richiesta)

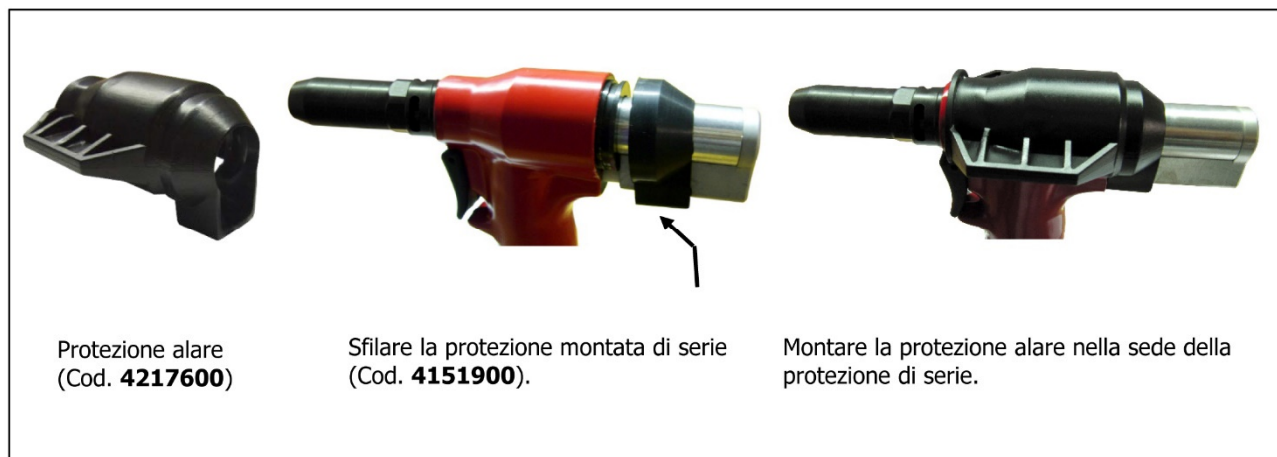

Questa protezione alare (Cod. **4217600**) è stata ideata per impiegare l'attrezzo nelle fasi di finitura di vari prodotti, dove è necessario fare particolare attenzione.

Insieme alla base in gomma dell'attrezzo consente di creare un piano di appoggio, evitando in questo modo che ci sia un eventuale contatto con la parte in metallo del corpo.

L'attrezzo viene fornito di serie con PROTEZIONE (11).

Togliere la PROTEZIONE (11) ed inserire
la PROTEZIONE (Cod. 4147200).



A secondo delle modalità operative dell'operatore di usare l'attrezzo è stata creata una PROTEZIONE (Cod. 4147200) che lo rende più silenzioso e con una diminuzione di fuoriuscita d'aria. Tale particolare è fornito solo a richiesta.

PARTICOLARI A RICHIESTA

LA FASTSETM12

VIENE FORNITA CON FONDELLO

LISCIO (RIF. A), A RICHIESTA

È POSSIBILE FORNIRE IL FONDELLO

+ GOLFARE MASCHIO (KIT. RIF. (B) COD. 4540500)

+ BILANCIATORE KG. 2/3 (COD. 0523200).

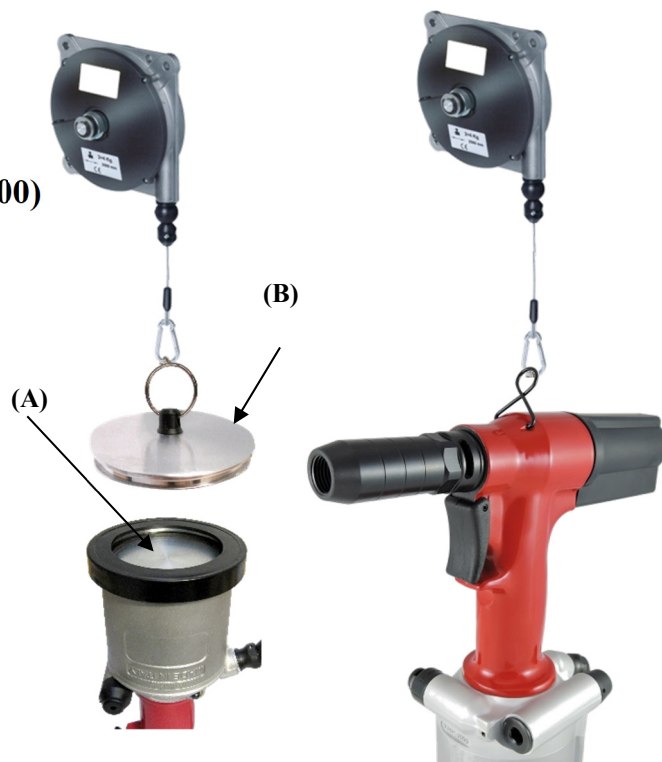

48

PROTEZIONE MOTORE IN GOMMA (Cod. 4796200)



PER LA FASTSETM12 È FORNIBILE SU RICHIESTA IL DEVIATORE D'ARIA ORIENTABILE (COD. 4280600).

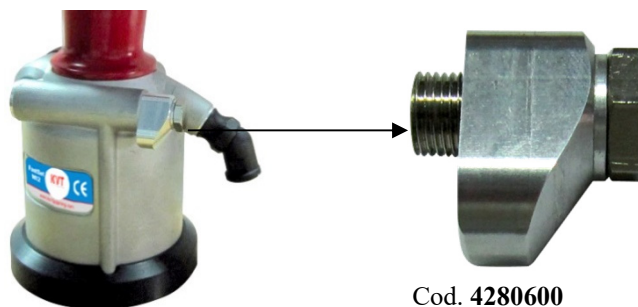

Cod. 4280600

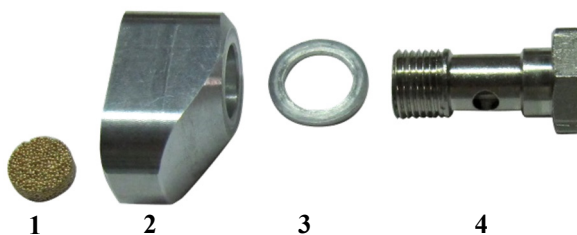

RIF.	CODICE	Q.TÀ	DESCRIZIONE
Fig. 2.5 - A	4280600	1	KIT COMPLETO DEVIATORE ARIA ORIENTABILE 
1.	4280700	1	FILTRO
2.	4280900	1	BLOCCHETTO
3.	3542800	1	RONDELLA TENUTA ARIA
4.	4281100	1	VITE TE SPECIALE



IL DEFLETTORE KIT 37 È MONTATO SUGLI ATTREZZI DI SERIE, IN CASO DI NECESSITÀ È FORNIBILE IL DEVIATORE SPECIALE D'ARIA ORIENTABILE (COD. 4280600).

INDICE

1 - INFORMAZIONI GENERALI	PAG. 159	3.1.2 KIT SPECIALE AD ALTA RESISTENZA PER M8 CON GHIERA FISSA	
1.1 ASSISTENZA		3.2 PARTI DI RICAMBIO DEL GRUPPO MOTORE (KIT 20)	
1.2 CERTIFICAZIONE E MARCATURA CE		3.2.1 KIT MOTORE COMPLETO COMPOSTO DA 5 ARTICOLI (COD. 4316600)	
1.3 GARANZIA		3.3 ORDINAZIONE RICAMBI	
1.4 STRUTTURA DEL MANUALE			
1.4.1 SCOPO E CONTENUTO			
1.4.2 DESTINATARI			
1.4.3 CONSERVAZIONE			
1.4.4 SIMBOLI UTILIZZATI			
2 - DESCRIZIONE MACCHINA	PAG. 161	4 - SICUREZZA	PAG. 184
2.1 PRINCIPIO DI FUNZIONAMENTO		4.1 AVVERTENZE GENERALI	
2.2 VIBRAZIONI		4.2 USO PREVISTO	
2.3 EMISSIONI SONORE		4.3 CONTROINDICAZIONI D'USO	
2.4 DATI TECNICI		4.4 RISCHI RESIDUI	
2.5 EQUIPAGGIAMENTO E ACCESSORI STANDARD		4.5 IDENTIFICAZIONE/MATRICOLA	
2.5.1 ACCESSORI A RICHIESTA		5 - INSTALLAZIONE	PAG. 186
2.5.1.1 PER APPLICAZIONE INSERTI FILETTATI		5.1 TRASPORTO E MOVIMENTAZIONE	
2.5.1.1.1 KIT PER INSERTI FILETTATI M3		5.2 STOCCAGGIO	
2.5.1.1.1.1 COMPOSIZIONE KIT M3		5.3 COLLEGAMENTI	
2.5.1.1.2 KIT PER INSERTI FILETTATI M4		5.3.1 PNEUMATICO	
2.5.1.1.2.1 COMPOSIZIONE KIT M4		5.4 ALIMENTAZIONE DELL'ARIA	
2.5.1.1.3 KIT PER INSERTI FILETTATI M5		5.5 CONTROLLI PRELIMINARI	
2.5.1.1.3.1 COMPOSIZIONE KIT M5			
2.5.1.1.4 KIT PER INSERTI FILETTATI M6		6 - FUNZIONAMENTO	PAG. 187
2.5.1.1.4.1 COMPOSIZIONE KIT M6		6.1 ADDETTI	
2.5.1.1.5 KIT PER INSERTI FILETTATI M8		6.2 PREPARAZIONE DELLA MACCHINA E CAMBIO VITE	
2.5.1.1.5.1 COMPOSIZIONE KIT M8		6.3 INFORMAZIONI	
2.5.1.1.6 KIT PER INSERTI FILETTATI M10			
2.5.1.1.6.1 COMPOSIZIONE KIT M10		7 - MANUTENZIONE	PAG. 192
2.5.1.1.7 KIT PER INSERTI FILETTATI M12		7.1 STATO DI MANUTENZIONE	
2.5.1.1.7.1 COMPOSIZIONE M12		7.2 PULIZIA	
2.5.1.1.8 KIT TESTINA PIANA CON BUSSOLA IN POLLICI 1/2-13 UNC		7.3 MANUTENZIONE ORDINARIA	
2.5.1.1.8.1 COMPOSIZIONE KIT 1/2-13UNC		7.3.1 RIPRISTINO OLIO CIRCUITO OLEODINAMICO	
2.5.1.2 PER APPLICAZIONE INSERTI MASCHI		7.3.2 PARTI SOTTOPOSTE AD AZIONE DI USURA	
2.5.1.2.1 KIT PER INSERTI MASCHI M4		7.4 KIT PER LA MANUTENZIONE A RICHIESTA	
2.5.1.2.1.1 COMPOSIZIONE KIT M4			
2.5.1.2.2 KIT PER INSERTI MASCHI M5		8 - INDIVIDUAZIONE GUASTI	PAG. 195
2.5.1.2.2.1 COMPOSIZIONE KIT M5		8.1 POSSIBILI PROBLEMI	
2.5.1.2.3 KIT PER INSERTI MASCHI M6			
2.5.1.2.3.1 COMPOSIZIONE KIT M6		9 - DIAGNOSTICA E RIPARAZIONI	PAG. 197
2.5.1.2.4 KIT PER INSERTI MASCHI M8		9.1 RIPARAZIONI	
2.5.1.2.4.1 COMPOSIZIONE KIT M8		9.2 RICHIESTA DI ASSISTENZA	
2.5.1.2.5 KIT PER INSERTI MASCHI M10			
2.5.1.2.5.1 COMPOSIZIONE KIT M10		10 - DEMOLIZIONE	PAG. 197
2.5.1.3 TESTINE PROLUNGHE		10.1 DEMOLIZIONE DELLA MACCHINA	
3 - RICAMBI	PAG. 180	11 - ALLEGATI	PAG. 197
3.1 PARTI DI RICAMBIO		11.1 DICHIARAZIONE	
3.1.1 KIT RAPIDO COMPLETO DI MOLLA			
3.1.1.1 COMPOSIZIONE KIT RAPIDO COMPLETO DI MOLLA			
3.1.1.1.1 GHIERA DENTATA SPECIALE PER VITE TCCEI M8. NON NECESSITA DELLA RIDUZIONE (COD. 3472600) (ACCESSORIO A RICHIESTA)			

1 - INFORMAZIONI GENERALI

1.1 - ASSISTENZA

Per qualsiasi necessità inerente l'uso, la manutenzione o la richiesta di parti di ricambio, il Cliente è tenuto a rivolgersi al distributore di zona autorizzato (oppure direttamente alla *KVT – FASTENING*), specificando i dati identificativi della Macchina riportati sul cilindro esterno:

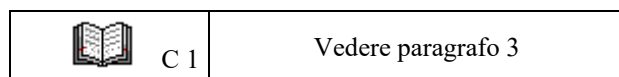

1.2 - CERTIFICAZIONE E MARCATURA CE

La Macchina è realizzata in conformità delle Direttive Comunitarie pertinenti ed applicabili nel momento della sua immissione sul mercato.

Non rientrando la Macchina nell'ALLEGATO IV della DIRETTIVA 2006/42/CE, la *KVT – FASTENING* provvede alla Autocertificazione per apporre la marcatura CE.

1.3 - GARANZIA

Il periodo di garanzia è di 12 mesi dalla data riportata sulla relativa Fattura o Bolla di Consegna.

La Garanzia comprende esclusivamente le parti sostituite, con esclusione della mano d'opera.

Non sono compresi nella Garanzia, sia gli accessori standard (vedere paragrafo 2.5) sia i danni alla Macchina causati da:

- trasporto e/o movimentazione
- errori dell'Operatore
- mancata manutenzione prevista dal presente Manuale (vedere capitolo 7)
- guasti e/o rotture non imputabili al malfunzionamento della stessa
- normale consumo delle parti soggette ad usura.

La manomissione/sostituzione non autorizzata di parti della macchina, l'uso di accessori, di utensili, di materiali di consumo diversi da quelli raccomandati dal costruttore potrebbero rappresentare un pericolo di infortunio e sollevano il costruttore dalla garanzia.

La *KVT – FASTENING* si assume la responsabilità solo se la macchina è difettosa all'origine e decade se l'utilizzatore non si adegua alle istruzioni fornite.

1.4 - STRUTTURA DEL MANUALE

Il Cliente deve leggere con estrema attenzione le informazioni riportate nel presente Manuale, in quanto una corretta Predisposizione, Installazione ed Utilizzazione della Macchina, costituiscono la base del rapporto Costruttore - Cliente.

1.4.1 - SCOPO E CONTENUTO

Questo Manuale ha lo scopo di fornire al Cliente tutte le informazioni necessarie affinché, oltre ad un adeguato utilizzo della Macchina, sia in grado di gestire la stessa nel modo più autonomo e sicuro possibile. Esso comprende informazioni inerenti l'aspetto Tecnico, il Funzionamento, la Manutenzione, i Ricambi e la Sicurezza.

Prima di effettuare qualsiasi operazione sulla Macchina, gli Operatori ed i Tecnici Qualificati devono leggere attentamente le istruzioni contenute nella presente pubblicazione.

In caso di dubbi sulla corretta interpretazione delle istruzioni, interpellare la *KVT – FASTENING* per ottenere i necessari chiarimenti.

1.4.2 - DESTINATARI

Il Manuale in oggetto è rivolto sia all'Operatore che ai Tecnici abilitati alla Manutenzione della Macchina.



Gli Utilizzatori non devono eseguire operazioni riservate ai Manutentori o ai Tecnici qualificati.

La *KVT – FASTENING* non risponde di danni derivanti dalla mancata osservanza di questo divieto.

1.4.3 - CONSERVAZIONE

Il Manuale di Istruzioni deve essere conservato nelle immediate vicinanze della Macchina, dentro un apposito contenitore e, soprattutto, al riparo da liquidi e quant'altro ne possa compromettere lo stato di leggibilità.

1.4.4 - SIMBOLI UTILIZZATI

SIMBOLO	SIGNIFICATO	COMMENTO
 P ...	PERICOLO	Indica un pericolo con rischio per l'Utilizzatore.
 A ...	AVVERTENZA	Indica un'avvertenza o una nota su funzioni chiave o su informazioni utili. Prestare la massima attenzione ai blocchi di testo indicati da questo simbolo.
 C ...	CONSULTAZIONE	Occorre consultare il Manuale Istruzioni prima di effettuare una determinata operazione.

2 - DESCRIZIONE MACCHINA

2.1 - PRINCIPIO DI FUNZIONAMENTO

La *Rivettatrice oleopneumatica per inserti, FASTSETM12* con regolazione a pressione olio (forza), viene utilizzata con:

- inserti filettati femmine, da M3 a M12;
- inserti filettati maschi, da M4 a M10

Il sistema oleopneumatico utilizzato e le parti meccaniche che compongono la struttura interna della *FASTSETM12*, rispetto ad altri modelli di rivettatrice, danno un'ottima affidabilità in riduzione dei problemi dovuti all'usura dei componenti, con conseguente aumento di durata e funzionalità. Le soluzioni tecniche adottate riducono le dimensioni e il peso della macchina rendendo la *FASTSETM12* assolutamente maneggevole.

2.2 - VIBRAZIONI

In condizioni di impiego conformi alle indicazioni di corretto utilizzo, le vibrazioni non sono tali da fare insorgere situazioni di pericolo.

2.3 - EMISSIONI SONORE

La Macchina è progettata e realizzata in modo da ridurre alla sorgente il livello di emissione sonora; infatti il livello di pressione acustica continuo equivalente ponderato A nel posto di lavoro dell'operatore non supera 80 dB (A).

In ogni caso, le informazioni citate, consentiranno all'Utente della Macchina di effettuare una migliore valutazione del pericolo e del rischio a cui è sottoposto.

2.4 - DATI TECNICI

Di seguito sono riportati i dati e le caratteristiche tecniche della Macchina a cui occorre fare riferimento per ogni eventuale contatto con l'Assistenza Tecnica della *KVT – FASTENING*.

TABELLA 2.4 A - DATI E CARATTERISTICHE

PRESSIONE ARIA DI ESERCIZIO	6 bar
PRESSIONE ARIA MIN – MAX	5 – 7 bar
CONSUMO ARIA PER CICLO A 6 BAR	5 litri
CORSA MAX	6,5 mm
MAX FORZA	26.600 N
VELOCITÀ MOTORE (AVVITAMENTO)	2200 rpm a 6,5 bar
VELOCITÀ MOTORE (SVITAMENTO CICLO)	1750 rpm a 6,5 bar
VELOCITÀ SVITAMENTO DIRETTO	1850 rpm a 6,5 bar
PESO (SENZA KIT)	2,200 Kg
VIBRAZIONI	< 2,5 m/s ²
RUMOROSITA'	76 dB (A)

Figura 2.4 – B



Figura 2.4 – C



RIF.	CODICE	Q.TÀ	DESCRIZIONE
Fig. 2.4 - C	3531800	1	KIT-TESTATA SPECIALE PROLUNGA
A/1.	3446600	1	CANOTTO PROLUNGA 90MM
A/2.	3446900	1	MANICOTTO PROLUNGA INTERNA 90MM

Ordinando questi due particolari si ottiene una prolunga di 165mm (Vedere fig. 2.4 – C).

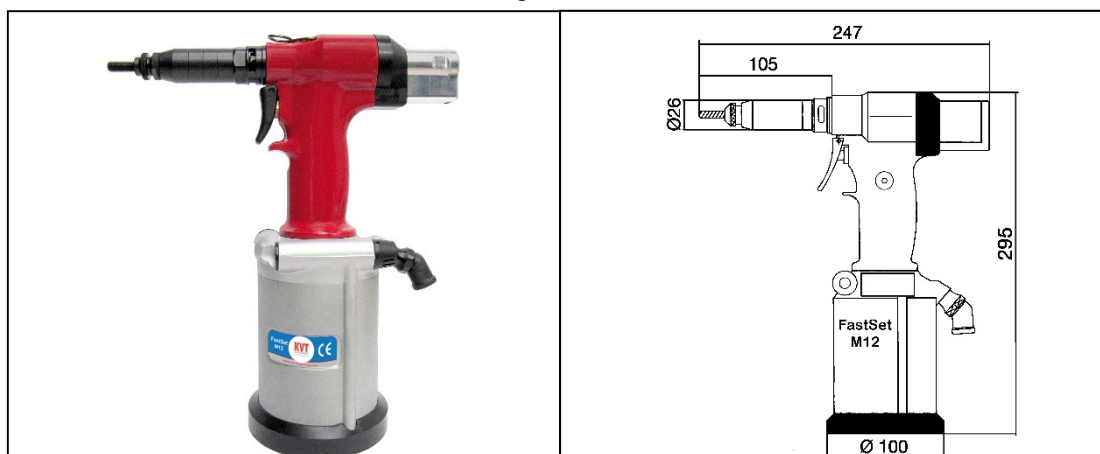
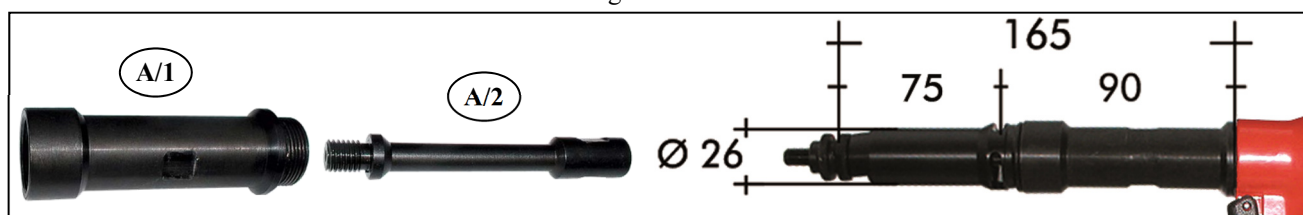
2.5 - EQUIPAGGIAMENTO E ACCESSORI STANDARD

Gli equipaggiamenti di seguito citati, sono riferiti a Macchine facenti parte della Produzione di serie.
Eventuali forniture speciali, potrebbero, di conseguenza, richiedere particolari diversi da quelli elencati.

Figura 2.5 – A

RIF.	CODICE	Q.TÀ	DESCRIZIONE	FASTSETM12-RIVETTATRICE OLEOPNEUMATICA PER INSERTI CON REGOLAZIONE PRESSIONE OLIO (FORZA)
Fig.2.5-A	4621500	1	FASTSETM12-RIVETTATRICE OLEOPNEUMATICA PER INSERTI IN CASSETTA	
50.	3064400	1	OLIO IDRAULICO TIPO ISO VG 32 100CC	
51.	0369800	1	VALIGIA IN PLASTICA	
52.	0207300	1	CHIAVE UNIVERSALE	
53.	2533800	1	PERNO REGOLAZIONE CORSA E EMERGENZA	
54.	4154200	1	CHIAVE REGOLAZIONE MM 3,0	
-	-	1	MANUALE DI ISTRUZIONI	

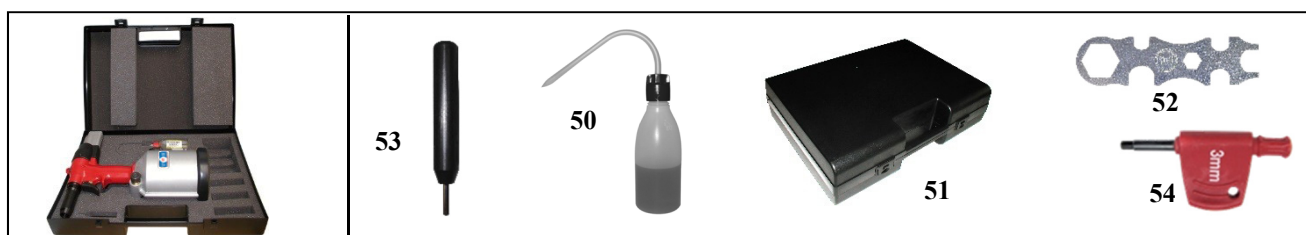

2.5.1 - ACCESSORI A RICHIESTA

La Macchina può essere fornita con diverse opzioni a seconda del tipo di prodotto da utilizzare.

2.5.1.1 - PER APPLICAZIONE INSERTI FILETTATI:

	KIT	CODICE
	M3	3441100
	M4	3441200
	M5	3441300
	M6	3441400
	M8	3441500
	M10	3441600
	M12	3441700
	1/2-13 UNC	4361600

I vari kit vanno avvitati in questa posizione



L'utilizzatore deve acquistare i seguenti KIT in relazione al prodotto da applicare.

 <p>A 1</p>	<p>È possibile ordinare la GHIERA per testina singolarmente (Cod. 0327700)..</p>	
 <p>A 2</p>	<div style="display: flex; align-items: center;">  <div style="margin-left: 20px;">  </div> </div> <p>TESTINA SPECIALE COMPLETA Ø 20,0 M8 (Cod. 4281000). È possibile fornire, a richiesta, la testina con diametri e fori diversi a secondo le esigenze.</p>	

2.5.1.1.1 KIT PER INSERTI FILETTATI M3

Figura 2.5 – B



RIF.	CODICE	Q.TÀ	DESCRIZIONE
Fig. 2.5 - B	3441100	1	KIT INSERTI FILETTATI VITE TCCEI M3

2.5.1.1.1.1 COMPOSIZIONE KIT M3

Figura 2.5 – C



TABELLA 2.5 - A

RIF.	CODICE	Q.TÀ	DESCRIZIONE
1.	3457500	1	TESTINA CON GHIERA PER VITE M3
2.	3457400	1	RIDUZIONE PER VITE M3
3.	3457600	1	VITE TCCEI M3x40 12.9 UNI5931/DIN912
4.	3466200	1	INNESTO ESAGONALE C/MOLLA PER VITE M3

A richiesta è possibile fornire la vite più lunga rispetto allo standard:

RIF.	CODICE	Q.TÀ	DESCRIZIONE
3a.	2193500	1	VITE TCCEI M3x50 12.9 UNI5931/DIN912

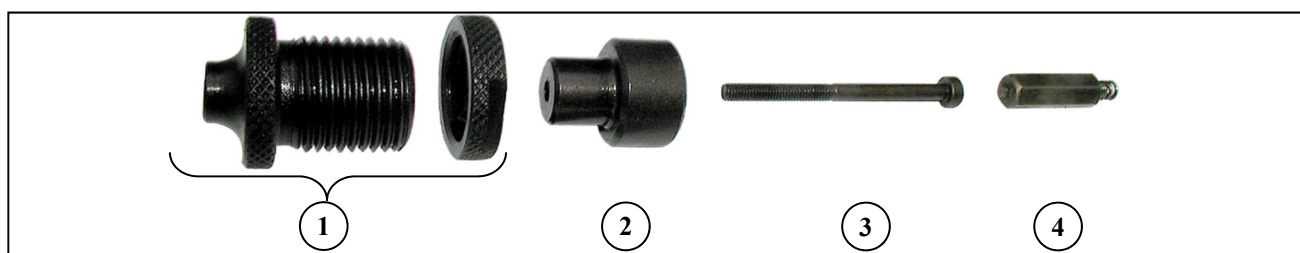

2.5.1.1.2 KIT PER INSERTI FILETTATI M4

Figura 2.5 – D



RIF.	CODICE	Q.TÀ	DESCRIZIONE
Fig. 2.5 - D	3441200	1	KIT INSERTI FILETTATI VITE TCCEI M4

2.5.1.1.2.1 COMPOSIZIONE KIT M4

Figura 2.5 – E





TABELLA 2.5 - B

RIF.	CODICE	Q.TÀ	DESCRIZIONE
1.	3470200	1	TESTINA CON GHIERA PER VITE M4
2.	3466300	1	RIDUZIONE PER VITE M4
3.	3470500	1	VITE TCCEI M4x55 12.9 UNI5931/DIN912
4.	3470600	1	INNESTO ESAGONALE C/MOLLA PER VITE M4

A richiesta è possibile fornire la vite più lunga rispetto allo standard:

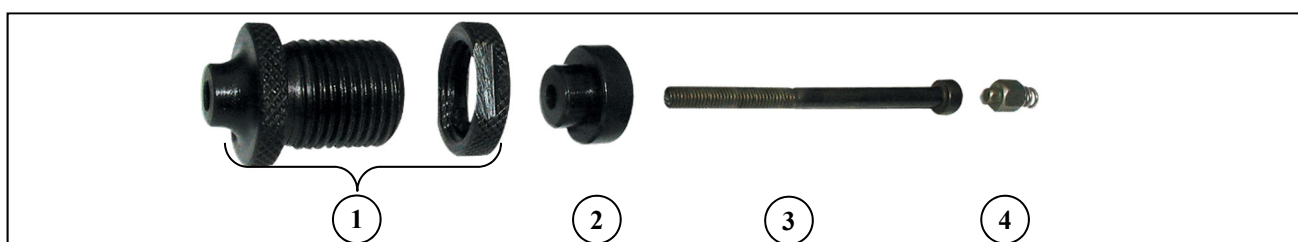
RIF.	CODICE	Q.TÀ	DESCRIZIONE
3a.	4186400	1	VITE TCCEI M4x65 12.9 UNI5931/DIN912 

2.5.1.1.3 KIT PER INSERTI FILETTATI M5

Figura 2.5 – F



RIF.	CODICE	Q.TÀ	DESCRIZIONE
Fig. 2.5 - F	3441300	1	KIT INSERTI FILETTATI VITE TCCEI M5

2.5.1.1.3.1 COMPOSIZIONE KIT M5

Figura 2.5 – G



TABELLA 2.5 - C

RIF.	CODICE	Q.TÀ	DESCRIZIONE
1.	3471800	1	TESTINA CON GHIERA PER VITE M5
2.	3471700	1	RIDUZIONE PER VITE M5
3.	3471900	1	VITE TCCEI M5x55 12.9 UNI5931/DIN912
4.	3472000	1	INNESTO ESAGONALE PER VITE M5

A richiesta è possibile fornire la vite più lunga rispetto allo standard:

RIF.	CODICE	Q.TÀ	DESCRIZIONE
3a.	4285500	1	VITE TCCEI M5x65 12.9 UNI5931/DIN912

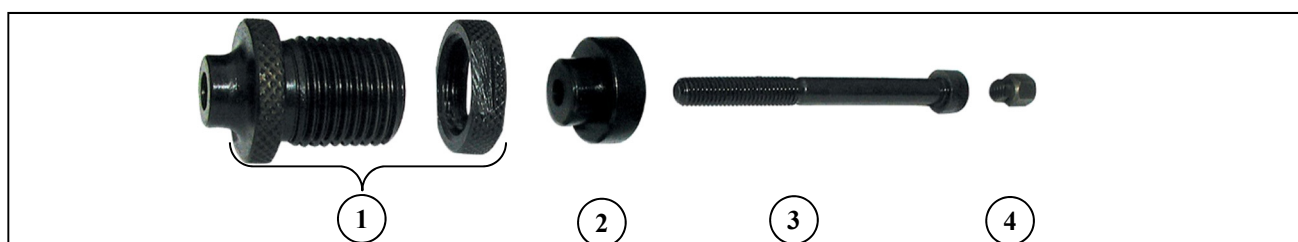

2.5.1.1.4 KIT PER INSERTI FILETTATI M6

Figura 2.5 – H



RIF.	CODICE	Q.TÀ	DESCRIZIONE
Fig. 2.5 - H	3441400	1	KIT INSERTI FILETTATI VITE TCCEI M6

2.5.1.1.4.1 COMPOSIZIONE KIT M6

Figura 2.5 – I





TABELLA 2.5 - D

RIF.	CODICE	Q.TÀ	DESCRIZIONE
1.	3472200	1	TESTINA CON GHIERA PER VITE M6
2.	3472100	1	RIDUZIONE PER VITE M6
3.	3472300	1	VITE TCCEI M6x55 12.9 UNI5931/DIN912
4.	3472500	1	INNESTO ESAGONALE PER VITE M6

A richiesta è possibile fornire la vite più lunga rispetto allo standard:

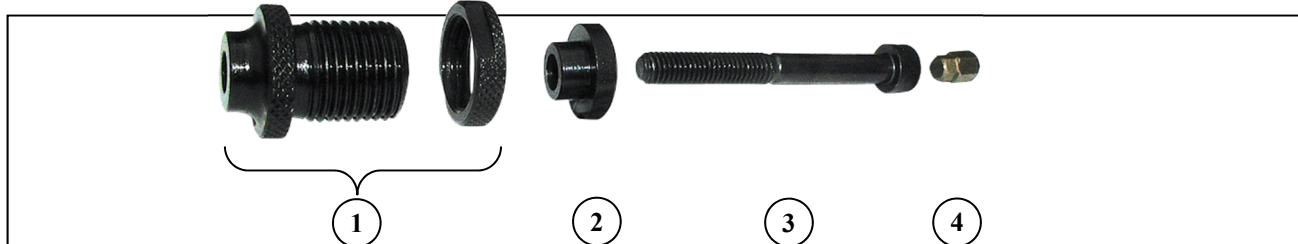
RIF.	CODICE	Q.TÀ	DESCRIZIONE
3a.	4285300	1	VITE TCCEI M6x65 12.9 UNI5931/DIN912 

2.5.1.1.5 KIT PER INSERTI FILETTATI M8

Figura 2.5 – J



RIF.	CODICE	Q.TÀ	DESCRIZIONE
Fig. 2.5 - J	3441500	1	KIT INSERTI FILETTATI VITE TCCEI M8

2.5.1.1.5.1 COMPOSIZIONE KIT M8

Figura 2.5 – K



TABELLA 2.5 - E

RIF.	CODICE	Q.TÀ	DESCRIZIONE
1.	3472700	1	TESTINA CON GHIERA PER VITE M8
2.	3472600	1	RIDUZIONE PER VITE M8
3.	3472800	1	VITE TCCEI M8x6012.9 UNI5931/DIN912
4.	3472900	1	INNESTO ESAGONALE PER VITE M8

A richiesta è possibile fornire la vite più lunga rispetto allo standard:

RIF.	CODICE	Q.TÀ	DESCRIZIONE
3a.	2192800	1	VITE TCCEI M8x65 12.9 UNI5931/DIN912

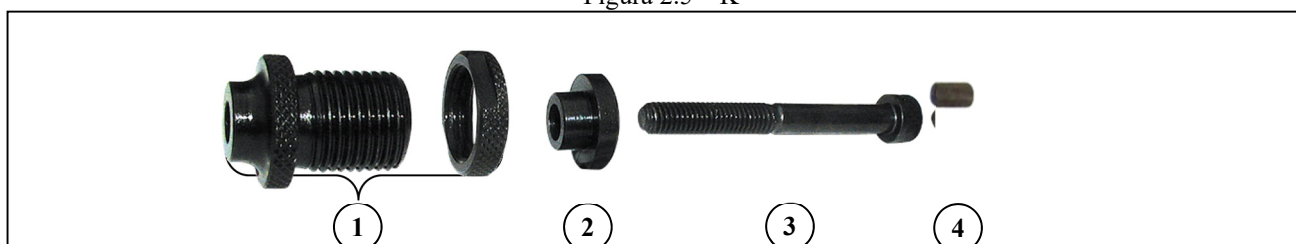

2.5.1.1.6 KIT PER INSERTI FILETTATI M10

Figura 2.5 – N



RIF.	CODICE	Q.TÀ	DESCRIZIONE
Fig. 2.5 - N	3441600	1	KIT INSERTI FILETTATI VITE TCCEI M10

2.5.1.1.6.1 COMPOSIZIONE KIT M10

Figura 2.5 – O



TABELLA 2.5 - G

RIF.	CODICE	Q.TÀ	DESCRIZIONE
1.	0329000	1	TESTINA CON GHIERA PER VITE M10
2.	3473100	1	VITE TCCEI M10x6012.9 UNI5931/DIN912
3.	3441800	1	INNESTO ESAGONALE PER VITE M10

A richiesta è possibile fornire la vite più lunga rispetto allo standard:

RIF.	CODICE	Q.TÀ	DESCRIZIONE
2a.	2428500	1	VITE TCCEI M10x70 12.9 UNI5931/DIN912
2b.	4180100	1	VITE TCCEI M10x1,25x60 12.9 UNI5931/DIN912

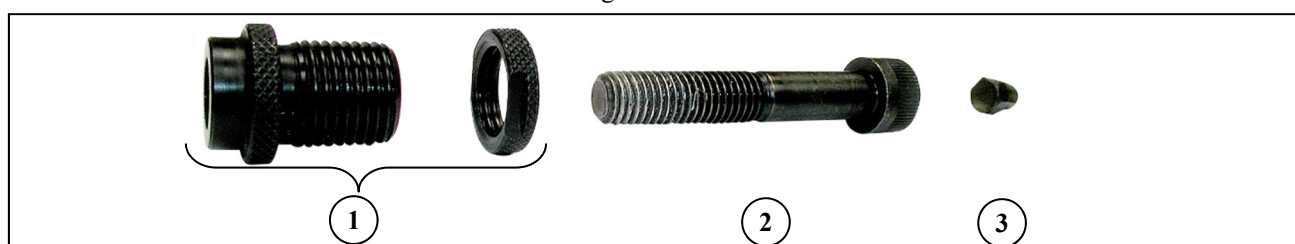

2.5.1.1.7 KIT PER INSERTI FILETTATI M12

Figura 2.5 – P



RIF.	CODICE	Q.TÀ	DESCRIZIONE
Fig. 2.5 - P	3441700	1	KIT INSERTI FILETTATI VITE SPECIALE M12

2.5.1.1.7.1 COMPOSIZIONE KIT M12

Figura 2.5 – Q



TABELLA 2.5 – H

RIF.	CODICE	Q.TÀ	DESCRIZIONE
1.	0329100	1	TESTINA CON GHIERA PER VITE M12
2.	4316200	1	GHIERA DENTATA BLOCCAGGIO VITE
3.	3473300	1	VITE TCCEI M12X60 12.9 (SPECIALE NON STANDARD)
4.	3473400	1	INNESTO ESAGONALE PER VITE M12

Vite TCCEI (brugola commerciale da tornire, vedi quote indicati in fig. 2.5-Q)

2.5.1.1.8 KIT TESTINA PIANA CON BUSSOLA IN POLLICI 1/2-13 UNC

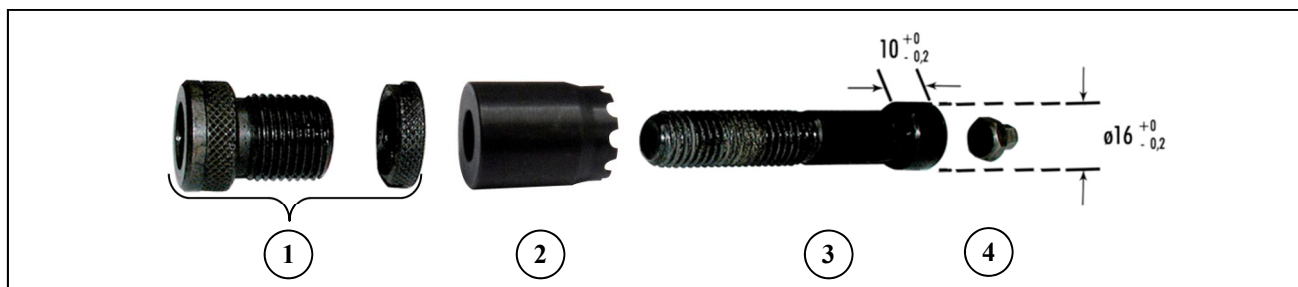
Figura 2.5 – R



RIF.	CODICE	Q.TÀ	DESCRIZIONE
Fig. 2.5 - R	4361600	1	KIT TESTINA PIANA CON BUSSOLA IN POLLICI 1/2-13 UNC

2.5.1.1.8.1 COMPOSIZIONE KIT 1/2-13UNC

Figura 2.5 – S





TABELLA 2.5 - I

RIF.	CODICE	Q.TÀ	DESCRIZIONE
1.	4378400	1	GRANO VCEI M8 X 6 CHIAVE A BRUGOLA 4MM
2.	4378500	1	BUSSOLA DOPPIO FILETTO M8 - 1/2-13 UNC
3.	4378600	1	TESTINA (FORO Ø 8,1)
4.	3472600	1	RIDUZIONE (FORO Ø 8,1)
5.	4187000	1	VITE TCCEI UNI 5931 CLASSE 8.8 M8x70
6.	3472900	1	INNESTO ESAGONALE PER VITE M8

 A 3	<p>MONTAGGIO KIT</p> <p>1-Allentare il grano di M8 (1). 2-Svitare bussola (2). 3-Montare vite (5) nella ghiera in dotazione alla Macchina (Cod. 4172400). 4-Accettarsi che il grano (1) sia stretto.</p>	
--	--	---

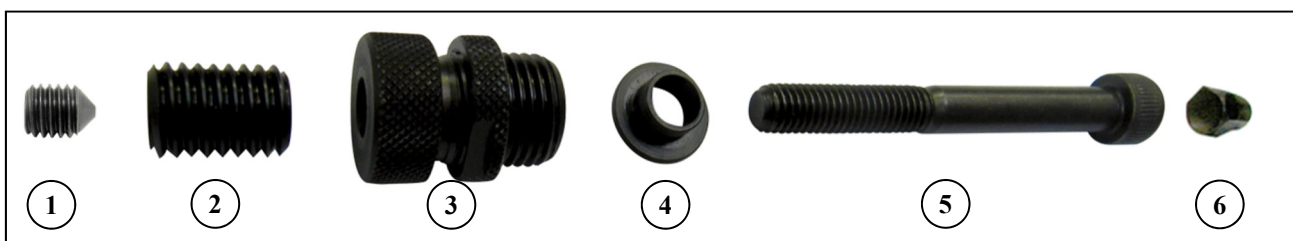
2.5.1.2 - PER APPLICAZIONE INSERTI MASCHI

	KIT	CODICE
	M4	3442300
	M5	3442400
	M6	3442500
	M8	3422600

I vari kit vanno avvitati in questa posizione

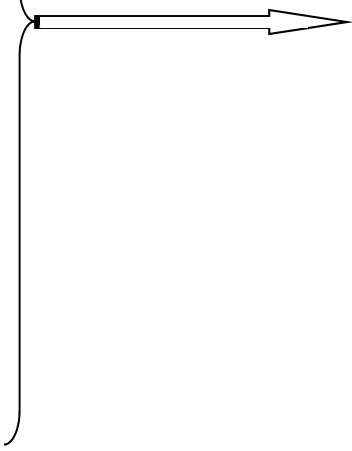

	M10	4601900
---	-----	---------

Per montare questo kit occorre smontare il kit rapido con molla.

L'utilizzatore deve acquistare i seguenti KIT in relazione al prodotto da applicare.

La Macchina può avere diversi tipi di equipaggiamenti per l'applicazione di INSERTI MASCHI.



 A 4	<p>È possibile ordinare la GHIERA per testina singolarmente (Cod. 0327700).</p>	
--	--	--

2.5.1.2.1 KIT PER INSERTI MASCHI M4

Figura 2.5 – T



RIF.	CODICE	Q.TÀ	DESCRIZIONE
Fig. 2.5 - T	3442300	1	KIT INSERTI MASCHI VITE TCCEI M4

2.5.1.2.1.1 COMPOSIZIONE KIT M4

Figura 2.5 – U



TABELLA 2.5 - J

RIF.	CODICE	Q.TÀ	DESCRIZIONE
1.	2561200	1	TESTINA CON GHIERA PER INSERTI MASCHI M4
2.	3441900	1	TIRANTE PER INSERTI MASCHI M4
3.	3441800	1	INNESTO ESAGONALE PER INSERTI MASCHI TCCEI M4

2.5.1.2.2 KIT PER INSERTI MASCHI M5

Figura 2.5 – V

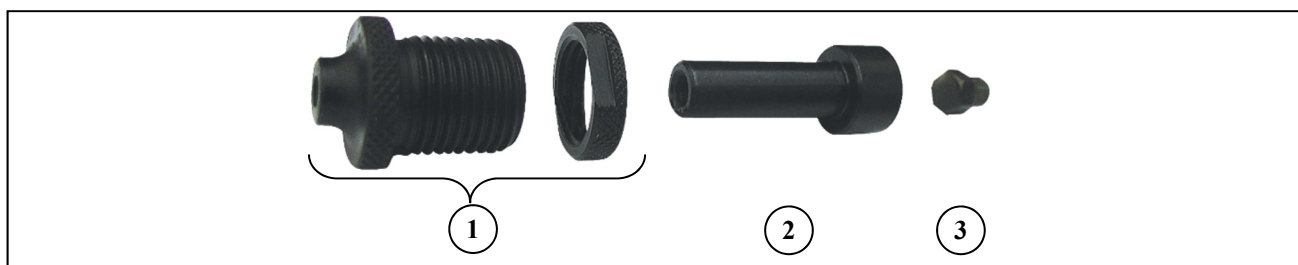

RIF.	CODICE	Q.TÀ	DESCRIZIONE
Fig. 2.5 - V	3442400	1	KIT INSERTI MASCHI VITE TCCEI M5

2.5.1.2.2.1 COMPOSIZIONE KIT M5

Figura 2.5 – W



TABELLA 2.5 - K

RIF.	CODICE	Q.TÀ	DESCRIZIONE
1.	2561300	1	TESTINA CON GHIERA PER INSERTI MASCHI M5
2.	3442000	1	TIRANTE PER INSERTI MASCHI M5
3.	3441800	1	INNESTO ESAGONALE PER INSERTI MASCHI TCCEI M5

2.5.1.2.3 KIT PER INSERTI MASCHI M6

Figura 2.5 – X

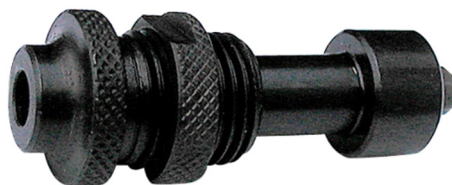

RIF.	CODICE	Q.TÀ	DESCRIZIONE
Fig. 2.5 - X	3442500	1	KIT INSERTI MASCHI VITE TCCEI M6

2.5.1.2.3.1 COMPOSIZIONE KIT M6

Figura 2.5 – Y



TABELLA 2.5 - L

RIF.	CODICE	Q.TÀ	DESCRIZIONE
1.	2561400	1	TESTINA CON GHIERA PER INSERTI MASCHI M6
2.	3442100	1	TIRANTE PER INSERTI MASCHI M6
3.	3441800	1	INNESTO ESAGONALE PER INSERTI MASCHI TCCEI M6

2.5.1.2.4 KIT PER INSERTI MASCHI M8

Figura 2.5 – Z

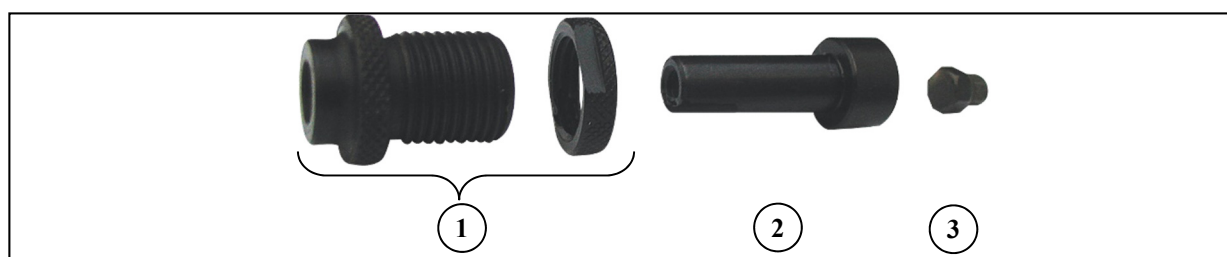

RIF.	CODICE	Q.TÀ	DESCRIZIONE
Fig. 2.5 - Z	3442600	1	KIT INSERTI MASCHI VITE TCCEI M8

2.5.1.2.4.1 COMPOSIZIONE KIT M8

Figura 2.5 – AA



TABELLA 2.5 - M
TABLE 2.5 - M

RIF.	CODICE	Q.TÀ	DESCRIZIONE
1.	2700500	1	TESTINA CON GHIERA PER INSERTI MASCHI M8
2.	4316200	1	GHIERA DENTATA BLOCCAGGIO VITE
3.	3442200	1	TIRANTE PER INSERTI MASCHI M8
4.	3441800	1	INNESTO ESAGONALE PER INSERTI MASCHI TCCEI M8

2.5.1.2.5 KIT PER INSERTI MASCHI M10

Figura 2.5 – AB



RIF.	CODICE	Q.TÀ	DESCRIZIONE
Fig. 2.5 - AB	4601900	1	KIT INSERTI MASCHI VITE TCCEI M10

2.5.1.2.5.1 COMPOSIZIONE KIT M10

Figura 2.5 – AC



TABELLA 2.5 - N

RIF.	CODICE	Q.TÀ	DESCRIZIONE
1.	4601700	1	TESTINA CON GHIERA PER INSERTI MASCHI D.10
2.	4601600	1	CANOTTO ESTERNO
3.	4601800	1	TIRANTE FEMMINA PER INSERTI MASCHI M10
4.	3540100	1	ATTACCO TIRANTE CON OR

2.5.1.3 - TESTINE PROLUNGHE

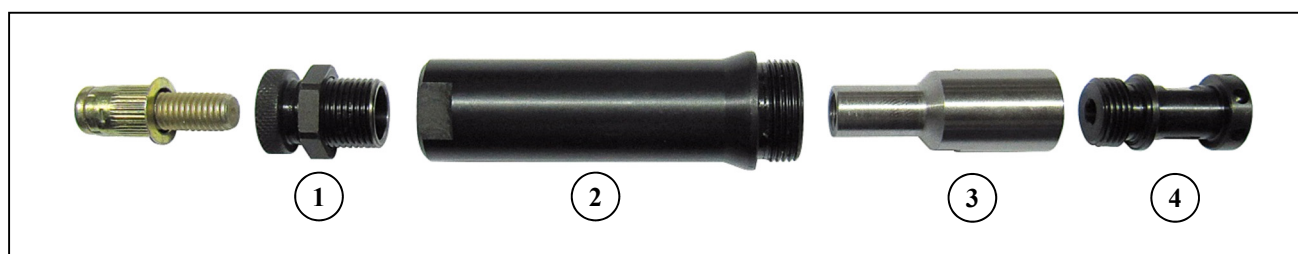
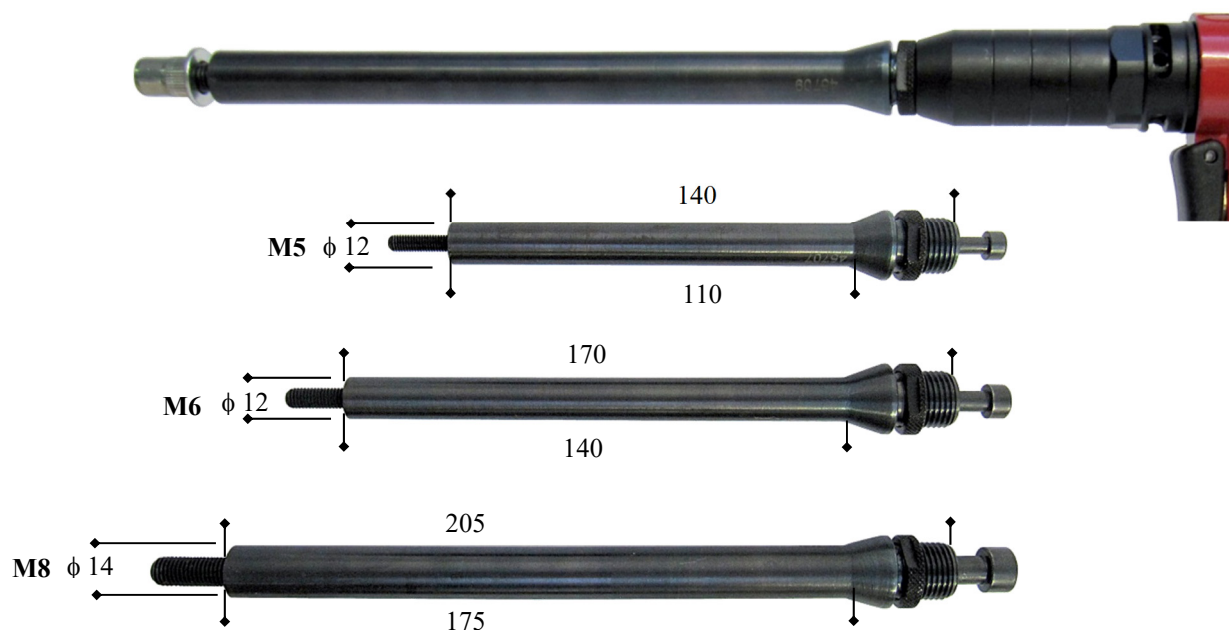

La lunghezza totale della prolunga si ottiene utilizzando la TESTINA PROLUNGA e il CANOTTO ESTERNO presente sulla Macchina.

RIF.	CODICE	Q.TÀ	DESCRIZIONE
Kit 110/140	4572500	1	KIT TESTINA PROLUNGA D.12X110/140MM X INSERTI FILETTATI M5
	4570700	1	TESTINA PROLUNGA D.12X110/140 PER INSERTI FILETTATI M5
	45513GR	1	VITE TCCEI UNI 5931/DIN 912 12.9 GR M5x170

RIF.	CODICE	Q.TÀ	DESCRIZIONE
Kit 140/170	4572600	1	KIT TESTINA PROLUNGA D.12X140/170MM X INSERTI FILETTATI M6
	4570800	1	TESTINA PROLUNGA D.12X140/170 PER INSERTI FILETTATI M6
	45702GR	1	VITE TCCEI UNI 5931/DIN 912 12.9 GR M6x200

RIF.	CODICE	Q.TÀ	DESCRIZIONE
Kit 175/205	4572700	1	KIT TESTINA PROLUNGA D.14X175/205MM X INSERTI FILETTATI M8
	4570900	1	TESTINA PROLUNGA D.14X175/205 PER INSERTI FILETTATI M8
	45514GR	1	VITE TCCEI UNI 5931/DIN 912 12.9 GR M8x240

Resta inteso che qualsiasi modifica e/o aggiunta di accessori, deve essere esplicitamente approvata e realizzata a cura della KVT – FASTENING.

3 - RICAMBI

3.1 - PARTI DI RICAMBIO

Figura 3.1 - A - Parti di ricambio

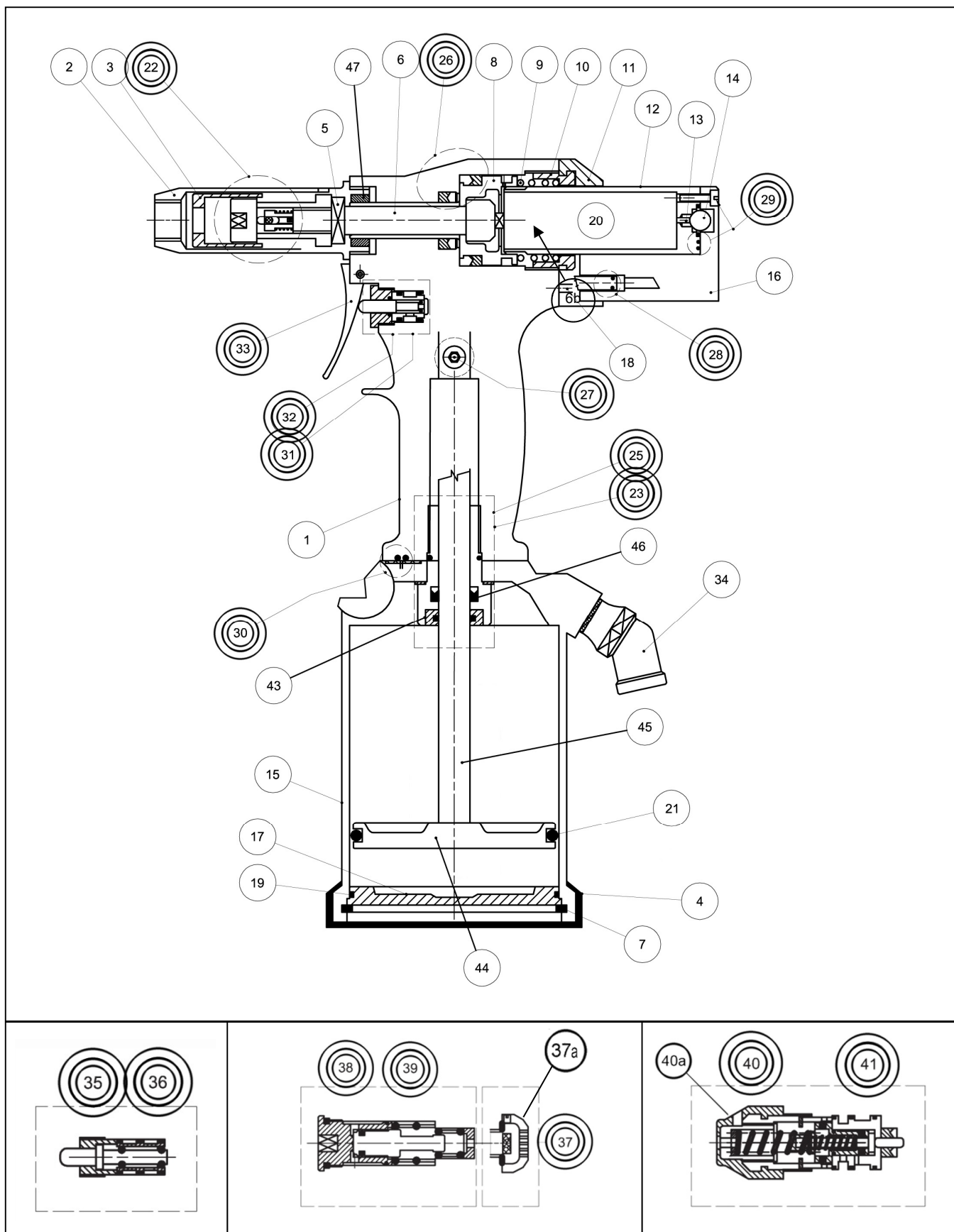

Vedere Figure 3.1 – A

TABELLA 3.1 - A

RIF..	CODICE	Q.TÀ	DESCRIZIONE	RIF.	CODICE	Q.TÀ	DESCRIZIONE
1.	4153100	1	CORPO IMPUGNATURA	26.	4151000	1	KIT GUARNIZIONI PISTONE 2 PZ 
2.	3539900	1	CONO ESTERNO 	27.	4175700	1	KIT TAPPO OLIO CON OR 
3.	4172400	1	GHIERA DENTATA BLOCCAGGIO VITI M3-M10	28.	4175600	1	KIT TUBI ARIA CON OR 6 PZ 
4.	4165100	1	BASE IN GOMMA	29.	4151100	1	KIT OR + VITI 5 PZ 
5.	4277200	1	GHIERA	30.	4152300	1	KIT GUARNIZIONE PIANA + OR 
6.	4151500	1	PERNO ROTAZIONE + RASAMENTO	31.	4151200	1	KIT OR 4 PZ 
6b.	3097900	1	RONDELLA DI RASAMENTO	32.	4156900	1	KIT COMPLETO CON OR 7 PZ 
7.	3093200	1	SEEGER BLOCCAGGIO FONDELLO	33.	4153400	1	KIT LEVA - SPINA 
8.	4151300	1	PISTONE OLIO	34.	3235500	1	ATTACCO ARIA SNODATO FILETTO 1/4" +1/4"GAS +ROND.ALL
9.	4151700	1	MOLLA	35.	4157000	1	KIT COMPLETO CON OR 8 PZ 
10.	5167800	1	GHIERA	36.	4156600	1	KIT OR 5 PZ 
11.	4151900	1	PROTEZIONE	37.	4291600	1	KIT DEFLETTORE 3 PZ 
12.	3761500	1	CORPO MOTORE	37a	4412900	1	DEFLETTORE
13.	3761300	1	ASTA	38.	4155800	1	KIT OR 7 PZ 
14.	3096900	1	SFERA	39.	4157100	1	KIT COMPLETO CON OR 13 PZ 
15.	4645300	1	CORPO ARIA	40.	4154400	1	KIT GUARNIZIONI 7 PZ 
16.	4152000	1	DISTRIBUTORE	40a.	4412100	1	PROTEZIONE PRESSOSTATO
17.	3762300	1	FONDELLO	41.	4647900	1	KIT COMPLETO 18 PZ 
18.	4152100	1	SPINA	43.	4645600	1	GHIERA CON GUARNIZIONE A LABBRO
19.	3762200	1	OR	44.	4645400	1	PISTONE
20.	3761000	1	GRUPPO MOTORE	45.	4645500	1	STELO
21.	3235600	1	OR	46.	4645700	1	GUARNIZIONE
22.	4174200	1	KIT RAPIDO CON MOLLA 	47.	5114200	1	ANELLO DI ARRESTO
23.	4647700	1	KIT GUARNIZIONI E GHIERA 	48.	4796200	1	PROTEZIONE MOTORE IN GOMMA 
25.	4647600	1	KIT GUIDA STELO COMPLETA 6 PZ 	-	4316600		VEDI KIT PAG. 183

3.1.1 - KIT RAPIDO COMPLETO DI MOLLA

Figura 3.1 - B



RIF.	CODICE	Q.TÀ	DESCRIZIONE
Fig. 3.1 - B	4174200	1	KIT RAPIDO CON MOLLA

3.1.1.1 - COMPOSIZIONE KIT RAPIDO COMPLETO DI MOLLA

Figura 3.1 - C

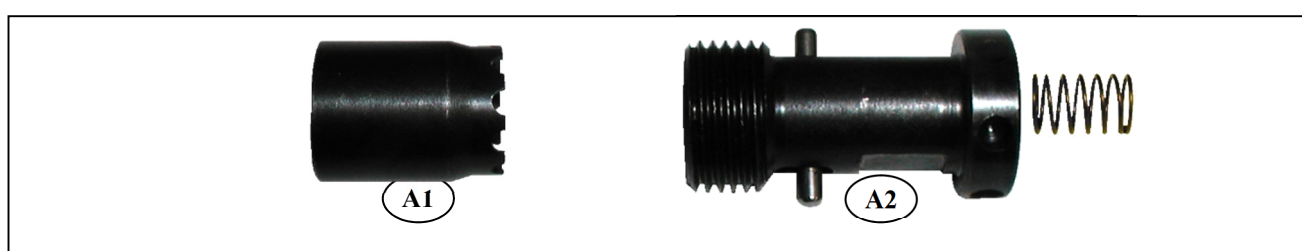

RIF.	CODICE	Q.TÀ	DESCRIZIONE
A1	4172400	1	GHIERA DENTATA BLOCCAGGIO VITI M3-M10
A2	4176900	1	ATTACCO VITE CON MOLLA

3.1.1.1.1 GHIERA DENTATA SPECIALE PER VITE TCCEI M8 NON NECESSITA DELLA RIDUZIONE (COD. 3472600) (ACCESSORIO A RICHIESTA)

Figura 3.1 - D

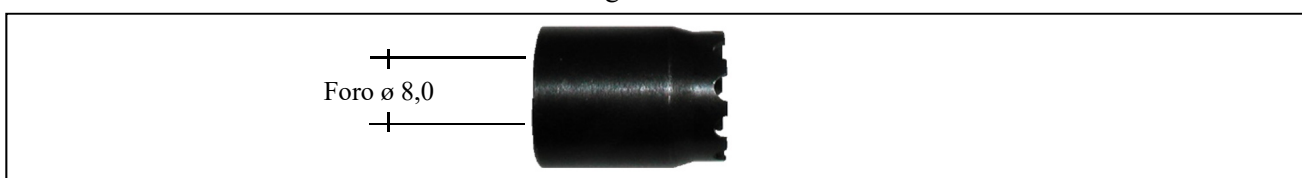

RIF.	CODICE	Q.TÀ	DESCRIZIONE
Fig. 3.1 - E	4280300	1	GHIERA DENTATA SPECIALE FORO Ø 8

3.1.2 - KIT SPECIALE AD ALTA RESISTENZA PER M8 CON GHIERA FISSA

Questo Kit è stato creato per chi ha necessità di utilizzare solo inserti M8.

Il materiale della ghiera di bloccaggio (Cod. **4508700**) è ad alta resistenza, cosicché la testa della brugola non va a rincalzare il materiale della stessa, mantenendo una tolleranza costante e una maggiore durata.



KIT Cod. 4508800

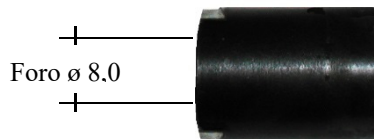

Cod. 4508700



Cod. 3540100

3.2 - PARTI DI RICAMBIO DEL GRUPPO MOTORE (KIT 20)

Figura 3.2 - A - Parti di ricambio motore

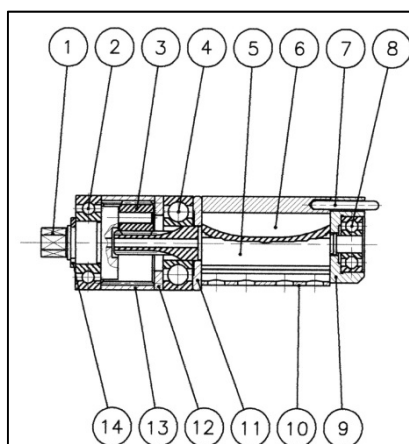

RIF.	CODICE	Q.TÀ	DESCRIZIONE				
Fig. 3.2 - A	3761000	1	GRUPPO MOTORE (20)				
RIF.	CODICE	Q.TA'	DESCRIZIONE	RIF.	CODICE	Q.TA'	DESCRIZIONE
1.	3763400	1	PORTASATELLITI ESTR	8.	3327300	1	CUSCINETTO
2.	3763300	1	CUSCINETTO	9.	3327400	1	PIATTELLO POSTERIORE
3.	3763200	3	SATELLITE	10.	3327000	1	STATORE
4.	3327500	1	CUSCINETTO	11.	3326900	1	PIATTELLO ANTERIORE
5.	3523400	1	ROTORE	12.	3763700	1	DISTANZIALE
6.	3327100	5	ALETTA	13.	3763600	1	CORONA
7.	3327200	1	RULLINO	14.	3763500	1	ANELLO SEEGER

N.B. in caso di ordinazione indicare sempre il RIF. e la DESCRIZIONE.

3.2.1 - KIT MOTORE COMPLETO COMPOSTO DA 5 ARTICOLI (Cod. 4316600)



3.3 - ORDINAZIONE RICAMBI

Si rammenta che solo i distributori di zona autorizzati possono effettuare riparazioni sulla Macchina, in loro mancanza si deve chiedere l'Intervento del Centro di Assistenza Tecnica della *KVT - FASTENING*, che è disponibile con Personale Qualificato, attrezzi ed attrezzature idonee, nonché con parti di ricambio originali.

Per effettuare l'ordine di ricambi sopra elencati, seguire le istruzioni elencate al paragrafo 1.2.

4 - SICUREZZA *SAFETY*

4.1 - AVVERTENZE GENERALI

L'Operatore deve leggere con molta attenzione le informazioni riportate nel presente Manuale, con particolare riguardo alle opportune precauzioni per la Sicurezza elencate in questo capitolo.

È indispensabile, inoltre, che l'Operatore segua le avvertenze di seguito elencate:

- Si raccomanda l'uso della Macchina da parte di personale specializzato;
- Mantenere la Macchina e la zona di lavoro in ordine e pulita;
- Appoggiare la Macchina verticalmente sulla base in gomma in una zona piana per evitare cadute;
- Non utilizzare la Macchina se non in condizioni psicofisiche normali;
- Indossare un vestiario idoneo al fine di evitare impedimenti e/o impigliamento pericoloso verso/dalla Macchina;
- Usare durante l'impiego dell'utensile occhiali o visiere protettive e guanti;
- Per eseguire le operazioni di manutenzione e/o di regolazione dell'utensile utilizzare gli accessori in dotazione indicati nel capitolo Manutenzione (vedere cap. 7);
- Non rimuovere od alterare le targhe apposte dalla *KVT – FASTENING* sulla Macchina;
- Non lasciare che persone estranee al lavoro tocchino gli utensili;
- Assicurarsi che i tubi di alimentazione dell'aria compressa siano correttamente dimensionati per l'uso previsto;
- Non trascinare l'utensile collegato all'alimentazione tirandolo per il tubo; mantenere quest'ultimo lontano da fonti di calore e da oggetti taglienti;
- Dopo avere eseguito operazioni di riparazione e/o registrazione assicurarsi di avere rimosso le chiavi di servizio o di registrazione;
- Prima di scollegare il tubo dell'aria compressa dall'attrezzo, assicurarsi che quest'ultimo non sia in pressione;
- Gli interventi di riparazione e pulizia dell'utensile dovranno essere eseguiti con Macchina non alimentata;
- Per le operazioni di carica olio usare solo fluidi con caratteristiche indicate nel presente fascicolo;
- In caso di perdite accidentali di olio che dovessero venire a contatto con la pelle, lavarsi accuratamente con acqua e sapone alcalino;
- È consigliabile, dove possibile, l'uso di un bilanciatore di sicurezza per sostenere la Macchina;
- Possibile rischio di colpi di frusta da parte dei tubi di aria compressa;
- Non puntare l'attrezzo verso l'operatore o altre persone che si trovino nelle vicinanze.

4.2 - USO PREVISTO

L'uso della Macchina è finalizzato esclusivamente all'utilizzo di inserti indicati al paragrafo 2.1, del tipo filettati femmina con filetto compreso tra M3 e M10, inserti filettati maschi con filetto compreso tra M3 e M10.

4.3 - CONTROINDICAZIONI D'USO

La Macchina non deve essere utilizzata:

- Per utilizzi diversi da quelli esposti al 4.2.
- In atmosfera esplosiva, aggressiva o ad alta concentrazione di polveri o sostanze oleose in sospensione nell'aria.
- In atmosfera a rischio d'incendio.
- Esposta alle intemperie.

4.4 - RISCHI RESIDUI

Durante il normale ciclo di lavorazione e durante la manutenzione, gli Operatori sono esposti ad alcuni rischi residui che, per la natura stessa delle operazioni, non possono essere totalmente eliminati:

- **Rischio di rottura del tubo di alimentazione, in quanto contiene aria compressa. È quindi indispensabile che non venga superato il valore di pressione massima indicata nei dati tecnici (vedere paragrafo 2.5).**

4.5 - IDENTIFICAZIONE/MATRICOLA



5 - INSTALLAZIONE

5.1 - TRASPORTO E MOVIMENTAZIONE

L'utensile può essere trasportato a mano ed è consigliabile dopo l'uso riporlo nel proprio imballo. Il corretto uso della valigia garantisce un trasporto sicuro.

 A 5	Danni alla macchina causati durante il Trasporto e la Movimentazione, non sono coperti da GARANZIA. Riparazioni o sostituzioni di parti danneggiate sono a carico del Cliente.
---	---

5.2 - STOCCAGGIO

In caso di lunga inattività, la Macchina deve essere immagazzinata con le precauzioni relative al luogo ed ai tempi di Stoccaggio:

- Immagazzinare la Macchina in luogo chiuso;
- Proteggere la Macchina da urti e sollecitazioni, utilizzando l'apposita valigia;
- Proteggere la Macchina dall'umidità e da escursioni termiche elevate;
- Evitare che la Macchina venga a contatto con sostanze corrosive.

5.3 - COLLEGAMENTI

Al fine di evitare qualsiasi tipo di problema al momento dell'avviamento della Macchina, è bene attenersi a quanto di seguito descritto.

5.3.1 - PNEUMATICO

L'allacciamento alla rete pneumatica si effettua con un tubo dotato di innesto rapido 1/4"+1/4" gas, da collegare al raccordo snodato fornito in dotazione con la Macchina.

Il tubo deve essere sufficientemente flessibile e soddisfare i requisiti di sicurezza relativi ai prodotti in pressione.

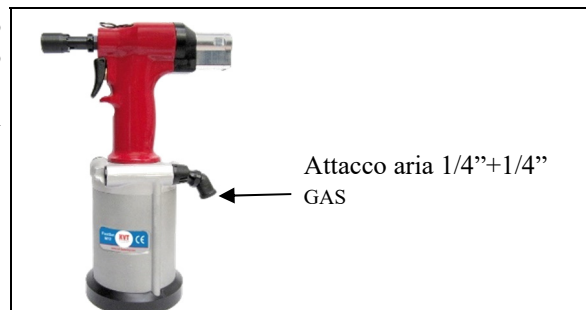

5.4 - ALIMENTAZIONE DELL'ARIA

L'aria di alimentazione deve essere libera da corpi estranei e da umidità per proteggere la Macchina da usura precoce delle parti in movimento; è consigliabile, pertanto, aria secca e non lubrificata.

5.5 - CONTROLLI PRELIMINARI

Prima della messa in funzione della Macchina, è necessario eseguire una serie di verifiche e controlli allo scopo di prevenire errori o incidenti durante la fase di Messa in funzione.

- Verificare che la Macchina non abbia subito danni durante la fase di trasporto.
- Controllare l'esatto collegamento del tubo dell'aria compressa all'attacco aria in dotazione alla macchina.
- Verificare il libero movimento e l'eventuale libera rotazione del motorino.

6 - FUNZIONAMENTO

6.1 - ADDETTI

La Macchina è stata concepita per l'utilizzo da parte di un solo Operatore.

Il Personale addetto ad operare sulla Macchina, deve possedere (oppure acquisire tramite adeguata formazione ed addestramento) i requisiti di seguito indicati, ed essere, inoltre, a conoscenza del presente Manuale e di tutte le informazioni relative alla Sicurezza:

- Cultura generale e tecnica a livello sufficiente per comprendere il contenuto del Manuale ed interpretare correttamente Disegni e Schemi
- Conoscenza delle principali Norme igieniche, antinfortunistiche e tecnologiche
- Conoscenza complessiva della linea e dello stabilimento in cui è inserita la Macchina
- Sapere come comportarsi in caso di Emergenza, dove reperire i mezzi di protezione individuale e come usarli correttamente.

I Manutentori, oltre alle caratteristiche sopracitate, devono avere anche una adeguata preparazione Tecnica.



P 1

MOTORE IN AVVITAMENTO

Quando si sostituisce il perno di rotazione (6 Cod. 4151500) per rottura, con uno nuovo, succederà che il motore giri di continuo in avvitamento, ciò vuol dire che l'asta (13 Cod. 3761300) è troppo lunga, in questo caso bisogna accorciarla di qualche decimo fino ad ottenere la chiusura della sfera (14 Cod. 3096900) con aria inserita l'asta non deve avere gioco assiale.

Al contrario della situazione precedente l'asta è troppo corta, va sostituita con un nuova, adattandola senza gioco assiale, con aria inserita, al fine di ottenere la chiusura della sfera (14 Cod. 3096900).

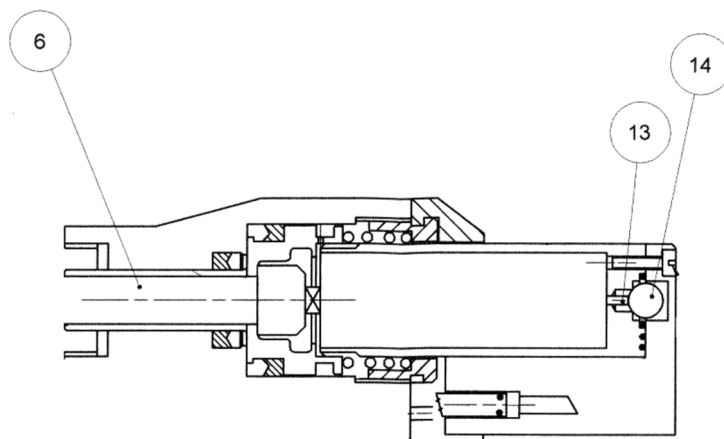

6.2 - PREPARAZIONE DELLA MACCHINA E CAMBIO VITE



P 2

Attenzione:

La preparazione della macchina e cambio vite da eseguire con attrezzo scollegato all'aria.

Figura 6.2 – A



Figura 6.2 – B

PER SVITARE GHIERA RAPIDA PORTA KIT

Stringere con due dita il pernetto, facendolo scorrere verso l'interno e contemporaneamente svitare la ghiera.

Accertarsi che la ghiera sia tipo largo 20 mm (Cod. 4277200) prima del montaggio, ciò evita problemi di tenuta del perno di rotazione.

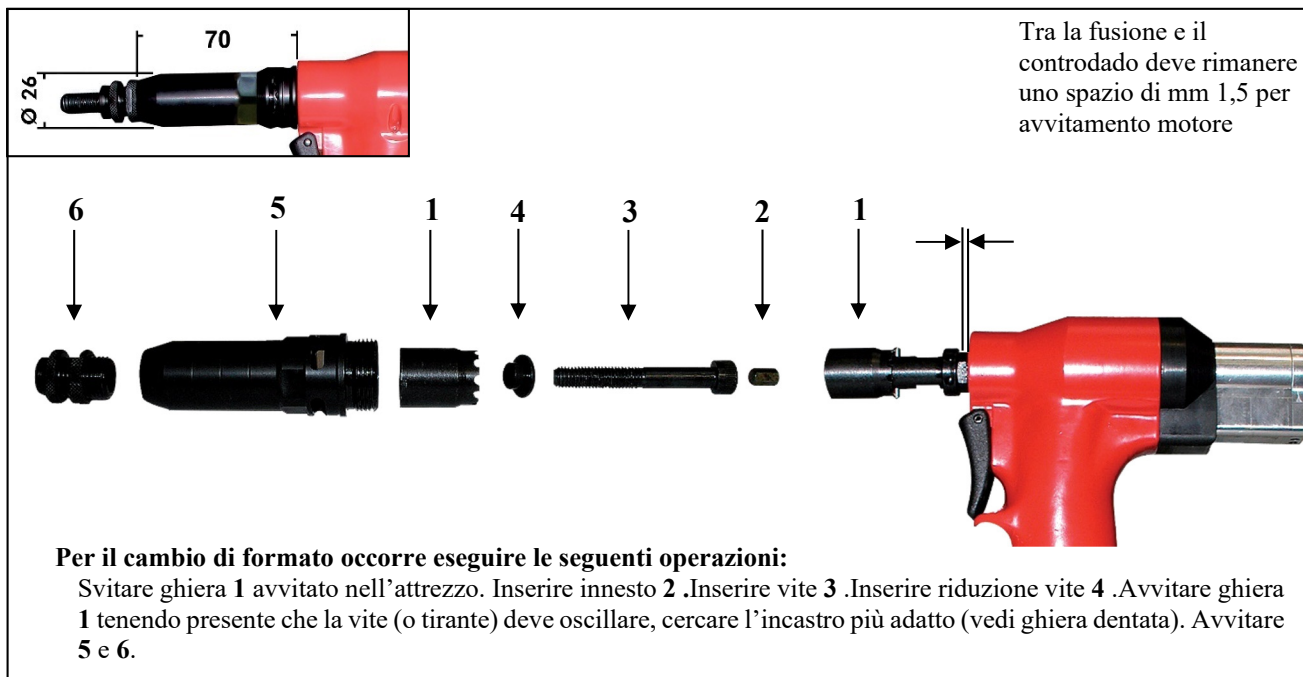

Figura 6.2 – C



REGOLAZIONE PRESSIONE OLIO (FORZA) - AVVITARE L'INSERTO

M3 BIANCA

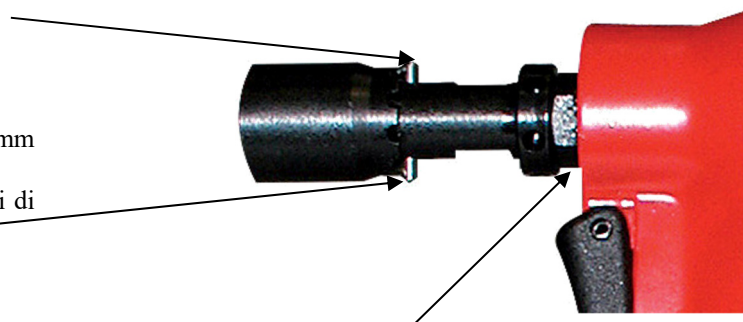
M4 }
M5 } VERDE

M6 }
M8 } ROSSA
M10 }

N.B. Queste regolazioni sono indicative, per dare all'operatore una guida; gli inserti, infatti, non sono uniformi come durezza e per questo motivo occorre apportare delle correzioni in più o in meno (+ o -).

IMPORTANTE

REGOLAZIONE PRESSIONE OLIO (FORZA).

Ruotando a destra, avvitando aumenta la forza.

Ruotando a sinistra, svitando diminuisce la forza.

ATTENZIONE

Quando la vite della regolazione pressione (FORZA) è tutta avvitata, lo svitamento si ha solo ad una pressione non inferiore a 6,5 bar (atm).

6.3 - INFORMAZIONI

Nel caso in cui l'inserto rimane bloccato o un ripensamento nell'atto dell'inserimento.

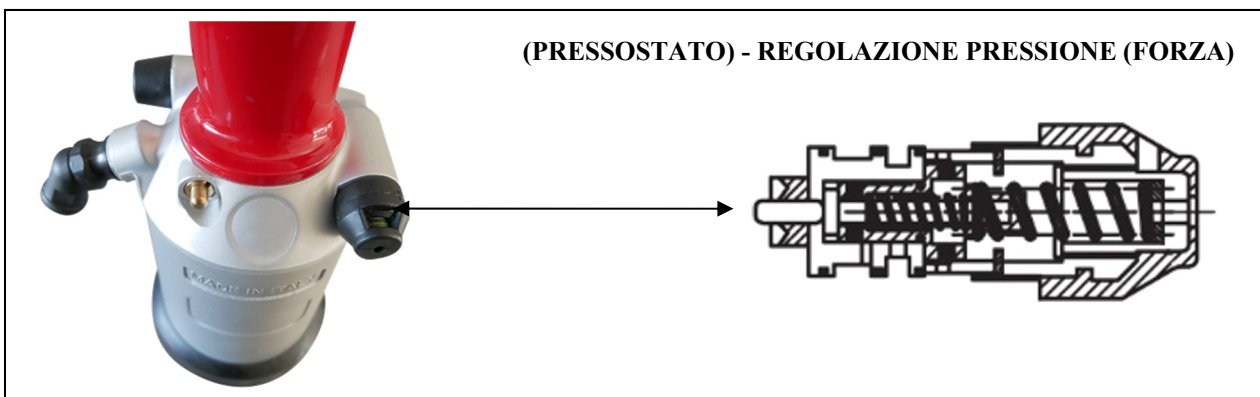
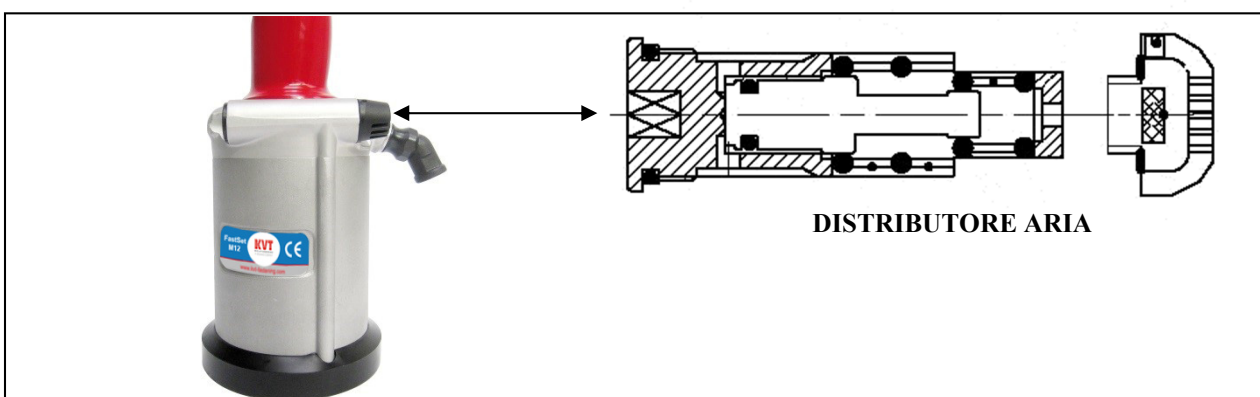
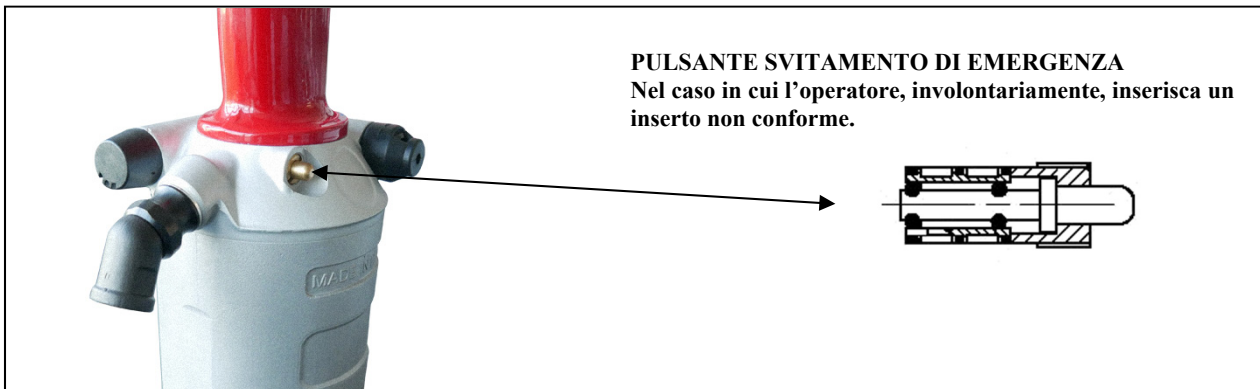

ATTENZIONE!!!

- 1- Il ciclo di svitamento può non avvenire quando l'inserto non è montato sulla vite (tirante); il pressostato non va in pressione.
- 2- L'olio non andando in pressione non permette al pressostato di fare lo svitamento.

Figura 6.3 – A

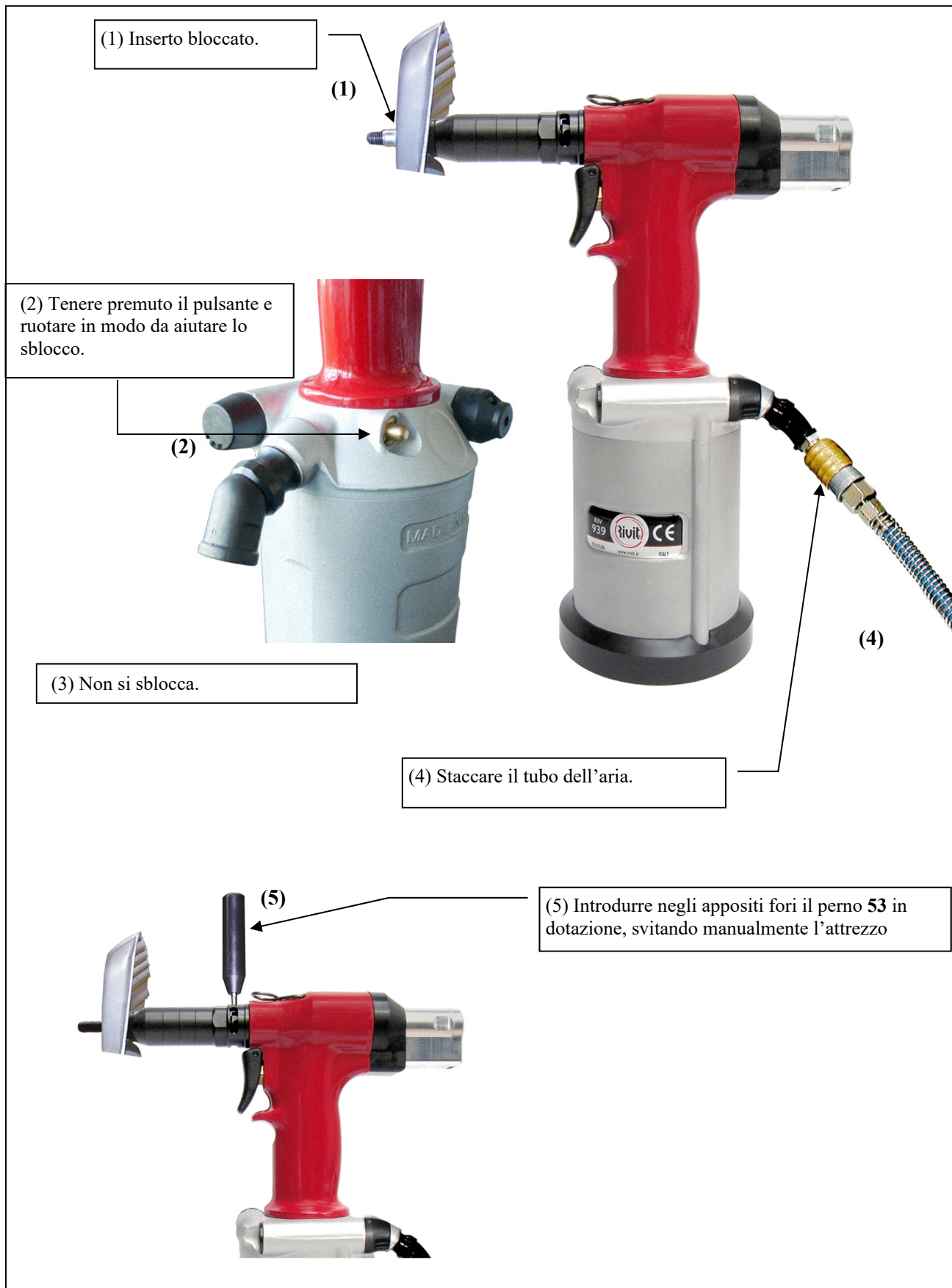

7 - MANUTENZIONE

7.1 - STATO DI MANUTENZIONE

Le manutenzioni devono essere effettuate a Macchina ferma e a energia pneumatica scollegata.

Raccomandazioni:

- Rispettare le istruzioni per la manutenzione della Macchina.
- A garanzia della sicurezza e di un perfetto funzionamento della Macchina è necessario che le eventuali sostituzioni siano effettuate esclusivamente con ricambi originali.

7.2 - PULIZIA

È bene provvedere periodicamente (dipende dal tipo e dalla frequenza di utilizzo) alla completa pulizia e ingrassatura della Macchina. Tale manutenzione deve essere fatta almeno una volta all'anno.



P 3

Escludere tutte le fonti di Alimentazione della Macchina.

Prima di effettuare le operazioni di pulizia, l'Operatore deve munirsi di mezzi idonei alla protezione individuale.

7.3 - MANUTENZIONE ORDINARIA

Vedere Figura 6.2 - A.

La Manutenzione ordinaria programmata, comprende ispezioni, controlli e interventi che, per prevenire fermate e guasti, tengono sotto controllo sistematico:

- Lo stato di lubrificazione della Macchina;
- Lo stato delle parti soggette ad usura.

7.3.1 - RIPRISTINO OLIO CIRCUITO OLEODINAMICO

Figura 7.3 – A

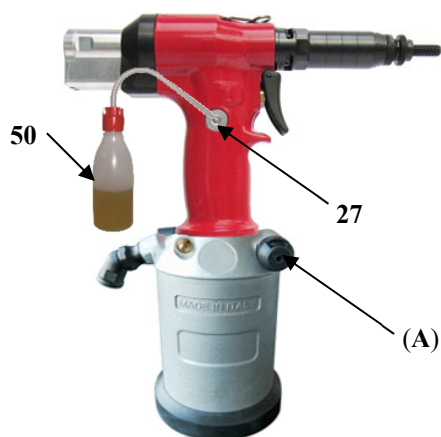

Il ripristino dell'olio del circuito oleodinamico si rende necessario dopo un lungo periodo di lavoro, quando si avverte un calo di corsa dell'attrezzo.

Procedere quindi come segue (vedere Figura 7.3 – A):

- Scollegare l'attrezzo all'aria compressa;
- Svitare tutto il pressostato (A) con la relativa chiave 54;
- Svitare il tappo e la relativa rondella 27;
- Porre in posizione orizzontale l'attrezzo e versare lentamente l'olio idraulico (tipo ISO VG 32) 50 fino a pieno riempimento del circuito;
- Avvitare il tappo con relativa rondella 27.
- Collegare l'attrezzo all'aria e azionare alcuni cicli a vuoto (non premere più il pulsante), svitare la vite 27 e accettarsi che il circuito sia pieno d'olio senza formazione di bolle d'aria.

Nell'effettuare le suddette operazioni è necessario essere muniti di guanti.

Non disperdere l'olio sostituito nell'ambiente, ma avvalersi delle ditte autorizzate al suo smaltimento.

Attenzione: in caso di perdite accidentali di olio che dovessero venire a contatto con la pelle, lavarsi accuratamente con acqua e sapone alcalino.

7.3.2 - PARTI SOTTOPOSTE AD AZIONI DI USURA

Controllare periodicamente lo stato di usura della base in gomma, in quanto è stata realizzata per garantire la stabilità dell'attrezzo. In caso di sostituzione, ordinare la base di ricambio alla *KVT – FASTENING* indicando anno/matricola della Macchina (vedere paragrafo 4.5).

Controllare periodicamente lo stato di usura delle viti e delle testine, sostituendole con le modalità indicate al paragrafo 6.2.

I pezzi di ricambio vanno richiesti citando i codici indicati al paragrafo 3.1.

7.4 - KIT PER LA MANUTENZIONE A RICHIESTA

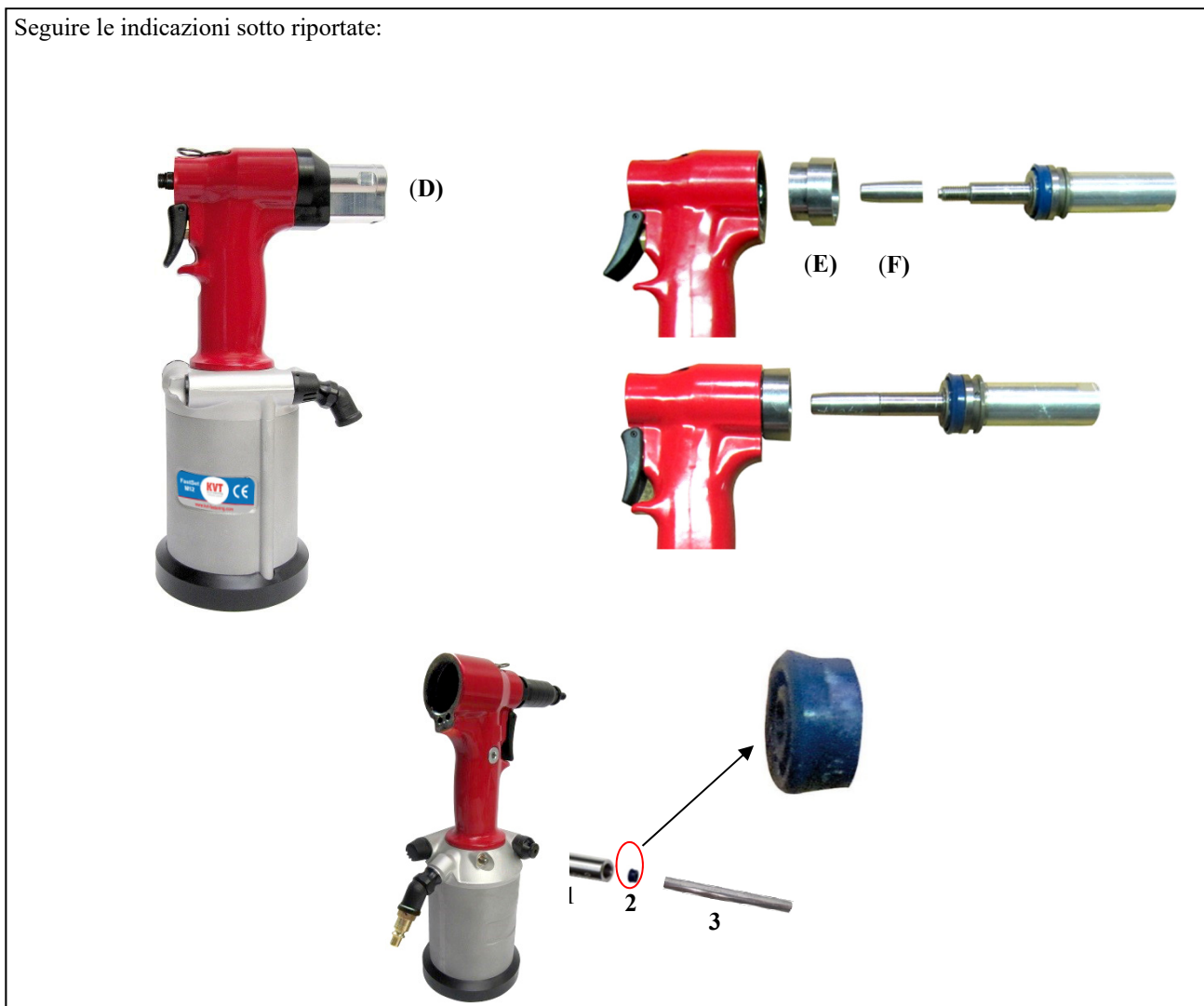

Seguire le indicazioni sotto riportate:





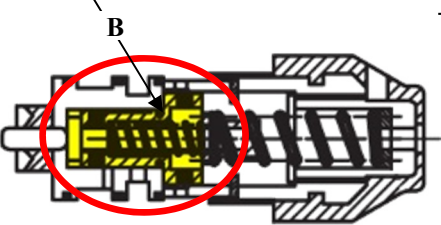
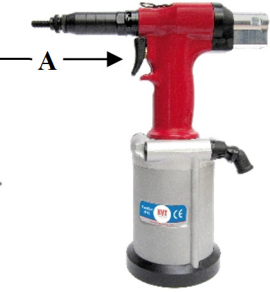

RIF.	CODICE	Q.TÀ	DESCRIZIONE
D.	4461800	1	MANICOTTO FRESATO PER AVVITARE E SVITARE GHIERA (10)
E.	4461900	1	BOCCOLA PER INTRODUZIONE PERNO DI ROTAZIONE (6) CON GUARNIZIONE MONTATA
F.	4461700	1	PUNTALE COPRIFILETTO INSERIMENTO PERNO DI ROTAZIONE (6) per non danneggiare guarnizione presente nel KIT (26)
1.+ 3.	4380800	1	BOCCOLA GUIDA + SPINA CILINDRICA ALLUMINIO Ø 8X78 PER INSERIRE GUARNIZIONE A LABBRO Ø 9 che si trova in fondo alla sede del pressostato (rif. C)
2.	-	1	GUARNIZIONE A LABBRO Ø 9 (rif. C) appartiene al KIT (41)

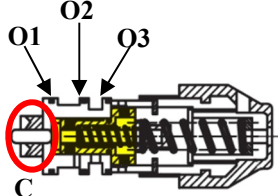
8 - INDIVIDUAZIONE GUASTI

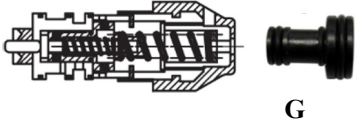
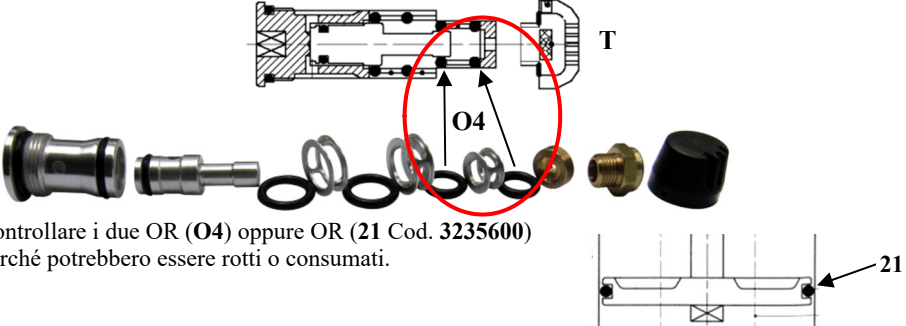
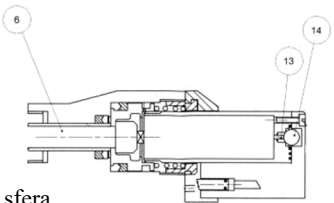
8.1 - POSSIBILI PROBLEMI

	<p>OR Cod. 4371800</p>  <p>B</p>	 <p>A</p>
CAUSA	SOLUZIONE	
Non fa la trazione.	Manca olio [vedere par. 7.3.1].	
La macchina non fa lo svitamento.	Inserendo l'inserto nel tirante dopo aver premuto il pulsante (A), la macchina non fa lo svitamento. L'olio non è sufficiente: aggiungere.	
Svita senza fare la trazione.	Or (B) rotto: sostituire.	 <p>B</p> <p>OR Cod. 4371800</p>
Ritarda lo svitamento dopo la trazione.	Lavorando intensamente perde l'ingrassatura e tende ad indurirsi. Perciò smontare il pistoncino (G) e ingrassare.	 <p>G</p>
Sostituzione particolari gruppo pressostato.	 <p>O1 O2 O3 C</p>  <p>1 2 3</p> <p>Quando si interviene sul gruppo pressostato.</p> <ol style="list-style-type: none"> 1. Staccare l'aria 2. Allentare il tappo olio (27) per evitare la fuoriuscita della guarnizione (C). Se dovesse essere sostituita usare la guida (1) inserendo la guarnizione (2) e spingerla con la spina (3). Se dopo il rimontaggio di tutti i componenti del pressostato, si nota un'anomalia del funzionamento, significa che sono stati montati male gli OR (O1, O2, O3): L'OR (O2), essendo rotto, svita senza fare la trazione. L'OR (O3) fa la trazione ma non svita. Dall'OR (O1) può fuoriuscire dell'aria. Perciò è consigliabile sostituire i 3 OR (ORM 15x1) che fanno parte del kit (rif. 41) cod. 4157200. 	

CAUSA	SOLUZIONE
Rallenta il tempo di passaggio dalla corsa allo svitamento.	Si risolve aprendo il pressostato e sfilando il pistoncino (G) ingrassandolo e rimontandolo. 
Perde aria dal silenziatore (T).	Controllare i due OR (O4) oppure OR (21 Cod. 3235600) perché potrebbero essere rotti o consumati. 
MOTORE in avvitemento	- Quando si sostituisce il perno di rotazione (6 Cod. 4151500) per rottura, con uno nuovo, succederà che il motore giri di continuo in avvitemento, ciò vuol dire che l'asta (13 Cod. 3761300) è troppo lunga, in questo caso bisogna accorciarla di qualche decimo fino ad ottenere la chiusura della sfera (14 Cod. 3096900). - Al contrario della situazione precedente l'asta è troppo corta, va sostituita con un nuova, adattandola senza gioco assiale, con aria inserita, al fine di ottenere la chiusura della sfera (14 Cod. 3096900). 
Montaggio kit rapido.	Montando il kit rapido (cod. 4176900), con aria inserita, accertarsi che rimanga uno spazio assiale pari a 1,5mm, tra il controdado e l'estremità del pistone. 
Perdita di giri durante lo svitamento o si ferma.	Quando si lavora intesamente è probabile che ci sia una perdita di giri nello svitamento o si ferma, occorre staccare il tubo dell'aria inserito e aggiungere alcune gocce d'olio nell'attacco dell'aria (rif. 34) e inserire nuovamente l'aria facendo ruotare il motore tramite il pulsante (P) per un paio di minuti, così il motore si pulisce e si lubrifica. 
Perde aria dal distributore aria.	Nel caso in cui si ha perdita di aria dal distributore aria è perchè il piattello del pistone è rotto. 

9 - DIAGNOSTICA E RIPARAZIONI

9.1 - RIPARAZIONI

Per assicurare la funzionalità e la sicurezza della Macchina, qualsiasi intervento di riparazione deve essere eseguito esclusivamente dal distributore di zona autorizzato o dal Centro Assistenza Tecnica della *KVT – FASTENING* (vedere paragrafo 1.2).

9.2 - RICHIESTA DI ASSISTENZA

Per qualsiasi tipo di informazione relativa all'Uso, alla Manutenzione, alla Installazione, alle Riparazioni, ecc. la *KVT – FASTENING* si ritiene sempre a disposizione delle richieste del Cliente.

Da parte di quest'ultimo è opportuno porre i quesiti in termini chiari, con riferimenti al presente Manuale e alle istruzioni elencate al paragrafo 1.2.

10 -DEMOLIZIONE

10.1 - DEMOLIZIONE DELLA MACCHINA

All'atto della Demolizione è necessario separare le parti in materiale plastico che devono essere inviate a raccolte differenziate nel rispetto della Normativa vigente.

Per quanto concerne la massa metallica della Macchina, è sufficiente la suddivisione tra le parti acciaiuse e quelle in altri metalli o leghe, per un corretto invio al riciclaggio per fusione.

L'olio contenuto nella Macchina non deve essere disperso nell'ambiente, ma occorre avvalersi delle ditte autorizzate al suo smaltimento.

11 -ALLEGATI

11.1 - DICHIARAZIONE

È allegata la seguente Dichiarazione:

- Dichiarazione di Conformità alla DIRETTIVA 2006/42/CE.

DICHIARAZIONE DI CONFORMITA'

DICHIARA

nella persona di:

Thomas Kraushaar
(Responsabile Legale)

sotto la propria esclusiva responsabilità che la Macchina

FASTSETM12

N° Matricola: _____

alla quale questa dichiarazione si riferisce è:

CONFORME

alle disposizioni della Direttiva Macchine 2006/42/CE

Documentazione tecnica presso:

**KVT-Fastening
Zweigniederlassung der Bossard AG Lagerstrasse 8
CH-8953 Dietikon / Zürich**

Date 19.11.19

Firma



KVT-Fastening

Zweigniederlassung der Bossard AG Lagerstrasse 8 CH-8953 Dietikon / Zürich

☎: +41 44 743 32 92 ☎:+41 44 740 65 66

www.kvt-fastening.ch