

Self-cutting screws

Direct screwing in one step



Intelligent assembly and disassembly
Wide range of possible applications



BOSSARD SELF-CUTTING SCREWS

Screwing tools

Screwdriver bits 1/4" for screws with Phillips cross recess

● **BN 31515** | short (length 25 mm); ○ **BN 10639** | long (length 50 mm)

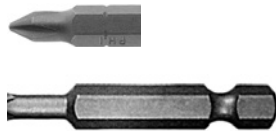

Size	●	○
0	●	
1	●	○
2	●	○
3	●	○
4	●	

Screwdriver bits 1/4" for screws with Pozidriv cross recess

● **BN 31514** | short (length 25 mm); ○ **BN 31516** | long (length 50 mm)

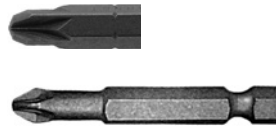

Size	●	○
1	●	○
2	●	○
3	●	○
4	●	

Hexagon socket wrench 1/4" bit for hexagon head screws, magnetic

● **BN 31522** | length 45 mm



Size	●
5,5	●
7	●
8	●
10	●
3/8"	●

Bitholder (extension) 1/4" for bits, magnetic

● **BN 31521** | length 72 mm



Size	●
1/4"	●

Screwdriver bits, square, 1/4" for screws with internal 8-kt BN 11904 / BN 1387 and internal 4-kt

● **BN 10318** | length 50 mm



Size	●
1	●
2	●

Subject to change without notice. Please refer to your local Bossard E-Shop for the current assortment and dimensions.
Other variants upon request.

BOSSARD SELF-CUTTING SCREWS

Advantages

Self-cutting screws drill their own tapping hole to close tolerances and form their mating thread themselves. The specially formed and stamped drill point prevents any drifting around the surface of the component and allows rapid spot drilling. There's no longer any need to centre punch the drilling point.

Thanks to these properties ecosyn®-drill and ecosyn®-MRX self-cutting screws can be worked quickly and cheaply. Savings of up to 50% are possible compared with conventional tapping screws.

Stamped drill points: safe and secure drilling without the need for prior centre punching

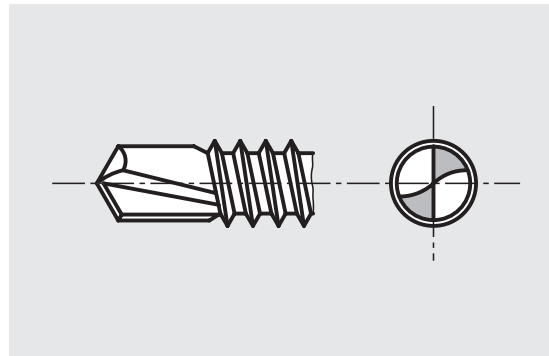

Self-cutting screws: fasten quickly and cheaply without the need for a pilot hole

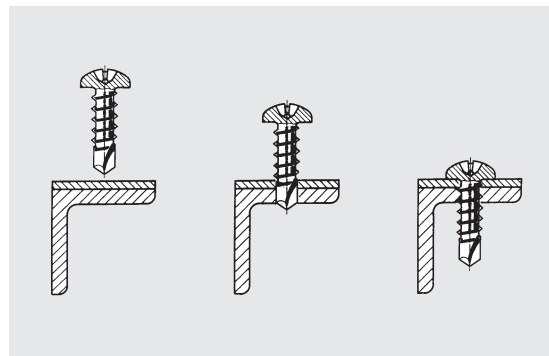

Connecting with	preparation	+	cost of the screw	=	total	Your Saving
tapping screws	● ● ● ● ●	+	●	=	● ● ● ● ● ● ●	
self-cutting crews	●	+	● ●	=	● ● ●	● ● ●

Subject to change without notice. Please refer to your local Bossard E-Shop for the current assortment and dimensions. Other variants upon request.

Note on working

In practice self-cutting screws are worked using electrical, power- or pneumatic screwdrivers at a speed of between 1000-2500 rpm and a contact pressure of between 150 – 300 N. For material which is difficult to drill through the appropriate rpm will have to be determined by trials.

Advantages

- No drilling or thread-cutting tools needed
- No centre punching
- No pre-drilling
- No thread cutting
- No hole offsetting in the component
- No additional securing elements needed
- High drilling performance
- Large process safety

Test data

The ecosyn®-drill and ecosyn®-MRX self-cutting screws meet the requirements of DIN 7504. The screwing rpm speeds and axial loads given in the table can be taken as typical values for use and assembly.

Areas of application and use

- Sheet metal construction
- Heating and ventilation ducts
- Household machines
- Vehicle body construction
- Window frames and blinds
- Façade construction
- Conservatories and winter gardens
- Construction of cabins
- And much more

Thread	Screwdriver speed under load [rpm]	Contact pressure* [N]
ST 2,9 – ST 3,9	1800 – 2500	ca. 150
ST 4,2 – ST 4,8	1800 – 2500	ca. 200
ST 5,5 – ST 6,3	1000 – 1800	ca. 250

Notes on mounting:

* if during the drilling the contact pressure is not high enough the cutting bit may anneal and so prevent the creation of a tapping hole.
Speeds of 1800 – 2500 rpm have proven appropriate for steel / aluminium fastened assemblies.

Subject to change without notice. Please refer to your local Bossard E-Shop for the current assortment and dimensions.
Other variants upon request.

BOSSARD SELF-CUTTING SCREWS

Comparison of self

Bossard ecosyn®-drill

ecosyn®-drill self-cutting screws are particularly suited for use in constructions made of aluminium and galvanized steel sheet up to a hardness of ca. 125 HV (tensile strength R_m max. 420 N/mm²), e.g. for ventilation ducts, cabins, motor-vehicle bodies and for sheathing in general construction of equipment and machinery.

ecosyn®-drill self-cutting screws are made from

case-hardened steel and are passive blue galvanized (free of CrVI).

When using galvanically zinc-plated self-cutting screws (tensile strength ≥ 1000 N/mm² or 320 HV) the risk of hydrogen embrittlement (risk of delayed brittle fracture) cannot be entirely excluded.

Bossard ecosyn®-MRX

ecosyn®-MRX self-cutting screws are manufactured from a martensitic, hardened and tempered chrome steel with higher resistance to corrosion (comparable with A2 grade stainless steel). Besides aluminium also sheet steel and rust-resistant thin sheet metal can also be drilled through.

When using self-cutting screws in aggressive environments and under certain climate conditions, stress corrosion cracking is possible.

The material used to make ecosyn®-MRX self-cutting screws is the result of a new development in

material technology. Compared with conventional materials used for rust-resistant self-cutting screws it offers additional advantages:

- strength greater than A2 or A4
- no erosion in the thread, even when using rust-resistant thin steel sheet
- no surface corrosion
- a screw for every type of application
- high drilling performance
- corrosion-resistant connections are economic and offer top reliability

Comparison of self-cutting screws

Screw Material	ecosyn®-drill case-hardened steel, galvanized	ecosyn®-MRX martensitic	Stainless steel austenitic A2 / A4 grade	Bimetal austenitic steel tips
Corrosion resistance				
- head	○	●	●	●
- thread	—	●	●	○
- drill points	—	●	●	—
Drills in				
- aluminium	●	●	●	●
- sheet steel	●	●	—	●
- rust resistant thin steel sheet	●	●	—	●

● suitable ○ limited suitability — unsuitable

Subject to change without notice. Please refer to your local Bossard E-Shop for the current assortment and dimensions. Other variants upon request.

ecosyn®-MRX self-cutting screws after 1,500 hours testing in the salt spray: from head to tip, no trace of any corrosion anywhere



The plug-in internal octagon drive should be processed using standard commercial square bits. It is ideally suited for use for mountings which are difficult to access.



The conical drive form of the bits means the screws stay attached to the tool even when working overhead.



Subject to change without notice. Please refer to your local Bossard E-Shop for the current assortment and dimensions. Other variants upon request.

DIN 7504 ECOSYN®-DRILL

For assemblies with acceptable corrosion resistance

Pan head self-drilling screws type N with Phillips type H cross

● **BN 1878** | Steel case-hardened, zinc plated blue



d ₁	2,9	3,5	[3,9]	4,2	4,8	5,5	6,3
d ₂	5,6	6,9	7,5	8,2	9,5	10,8	12,5
k max.	2,2	2,6	2,8	3,05	3,55	3,95	4,55
⊕	1	2	2	2	2	3	3
m ~	3	4,2	4,4	4,6	5	6,5	7,1
IK	0,7 - 1,9	0,7 - 2,25	0,7 - 2,4	1,75 - 3	1,75 - 4,4	1,75 - 5,25	2 - 6

d ₁	2,9	3,5	[3,9]	4,2	4,8	5,5	6,3
9,5	●	●	●				
13	●	●	●	●	●		
16	●	●	●	●	●		
19	●	●	●	●	●	●	●
22		●	●	●	●	●	●
25		●	●	●	●	●	●
L 32		●	●	●	●	●	●
38			●	●	●	●	●
45			●	●	●	●	●
50				●	●	●	●
60					●	●	●
70					●	●	●
80							●

Pan head self-drilling screws ~type N with with 8-lobe drive for 4edge-screw driver bits

● **BN 11904** | Steel case-hardened, zinc plated blue

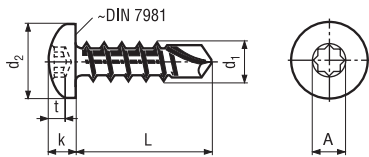

d ₁	3,5	[3,9]	4,2	4,8
d ₂ max.	6,9	7,5	8,2	9,5
k max.	2,8	3	3,45	3,65
⊕	1	1	2	2
t max.	1,75	2,05	2,25	2,45
A ~	3,2	3,5	4,5	4,8
IK	0,7 - 2,25	0,7 - 2,4	1,75 - 3	1,75 - 4,4

d ₁	3,5	[3,9]	4,2	4,8
9,5	●			
13	●	●	●	
16	●	●	●	●
19	●	●	●	●
L 25		●	●	●
32			●	●
38			●	●
45				●
50				●

Subject to change without notice. Please refer to your local Bossard E-Shop for the current assortment and dimensions. Other variants upon request.

Flat head self-drilling screw type P with Phillips type H cross

● **BN 1879** | Steel case-hardened, zinc plated blue

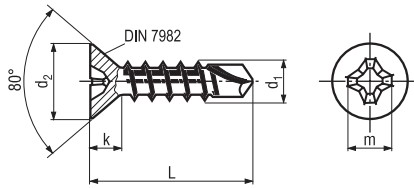

d ₁	2,9	3,5	[3,9]	4,2	4,8	5,5	6,3
d ₂	5,5	6,8	7,5	8,1	9,5	10,8	12,4
k max.	1,7	2,1	2,3	2,5	3	3,4	3,8
⊕	1	2	2	2	2	3	3
m ~	3	4,2	4,6	4,7	5,1	6,8	7,1
K	0,7	0,7	0,7	1,75	1,75	1,75	2
	-1,9	-2,25	-2,4	-3	-4,4	-5,25	-6

d ₁	2,9	3,5	[3,9]	4,2	4,8	5,5	6,3
9,5		●					
13	●	●	●	●			
16	●	●	●	●	●		
19	●	●	●	●	●	●	●
22		●	●	●	●	●	●
25		●	●	●	●	●	●
L 32		●	●	●	●	●	●
38			●	●	●	●	●
45				●	●	●	●
50				●	●	●	●
60					●	●	●
70					●	●	●
80						●	●

Hexagon head self-drilling screws type K

● **BN 1880** | Steel case-hardened, zinc plated blue

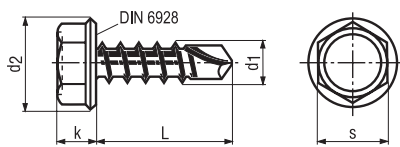









d ₁	3,5	[3,9]	4,2	4,8	5,5	6,3
d ₂ max.	8,3	8,3	8,8	10,5	11	13,2
k max.	3,4	3,4	4,1	4,3	5,1	5,9
s	5,5	5,5	7	8	8	10
K	0,7	0,7	1,75	1,75	1,75	2
	-2,25	-2,4	-3	-4,4	-5,25	-6

d ₁	3,5	[3,9]	4,2	4,8	5,5	6,3
9,5	●					
13	●	●	●	●		
16	●	●	●	●	●	
19	●	●	●	●	●	●
22	●	●	●	●	●	●
25	●	●	●	●	●	●
L 32			●	●	●	●
38			●	●	●	●
45			●	●	●	●
50			●	●	●	●
60				●	●	●
70				●	●	●
80				●	●	●

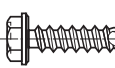
Subject to change without notice. Please refer to your local Bossard E-Shop for the current assortment and dimensions.
Other variants upon request.

For other self-cutting screws refer to the Bossard catalog

			Material	Surface	BN	Diameter
		Hexagon building screws, self-tapping with sealing washer	case-hardened steel	blue-galvanized	6031	6,3
		Hexagon building screws, self-tapping with sealing washer	aluminium		6033	5,6
		Hexagon building screws, self-tapping without sealing washer	case-hardened steel	blue-galvanized	6032	4,2 + 6,3
		Countersunk head self-tapping screws with ribs and wings, Philips cross recess	case-hardened steel	blue-galvanized	1005	4,2 - 6,3

Further dimensions available on request

Subject to change without notice. Please refer to your local Bossard E-Shop for the current assortment and dimensions. Other variants upon request.

DIN 7504 ECOSYN®-MRX

For corrosion-resistant assemblies

Pan head self-drilling screws type N with Pozidriv type Z cross

● **BN 14727** | Stainless steel

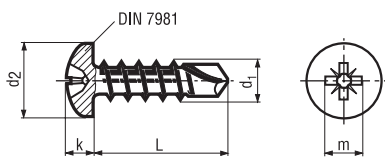

d ₁	ST 3,5	[ST 3,9]	ST 4,2	ST 4,8
d ₂ max.	6,9	7,5	8,2	9,5
k max.	2,6	2,8	3,05	3,55
⊕	2	2	2	2
m ~	3,9	4,1	4,3	4,7
⊠ K	0,7 - 2,25	0,7 - 2,4	1,75 - 3	1,75 - 4,4

d ₁	3,5	[3,9]	4,2	4,8
9,5	●			
13	●	●	●	●
16	●	●	●	●
19	●	●	●	●
22	●	●		
L	●	●	●	●
32		●	●	●
38			●	●
45				●
50				●
60				●

Pan head self-drilling screws with with 8-lobe drive for 4edge-screw driver bits

● **BN 1387** | INOX

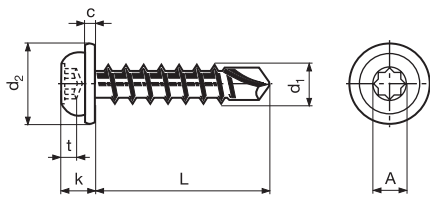

d ₁	ST 4,2	ST 4,8
d ₂ max.	9,7	11,1
k max.	3,5	4
c	1,1	1,3
⊕	S2	S2
t max.	2,5	2,8
A ~	4,5	4,8
⊠ K	1,75 - 3	1,75 - 4,4

d ₁	ST 4,2	ST 4,8
13	●	●
16	●	●
19	●	●
25	●	●
L	●	●
32	●	●
35		●
38		●
50		●

Subject to change without notice. Please refer to your local Bossard E-Shop for the current assortment and dimensions.
Other variants upon request.

Countersunk (flat) head self-drilling screws type P with Pozidriv type Z cross

● **BN 14728** | Stainless steel

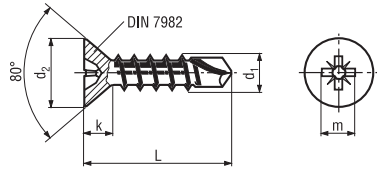

d ₁	ST 3,5	[ST 3,9]	ST 4,2	ST 4,8
d ₂ max.	6,8	7,5	8,1	9,5
k ~	2,1	2,3	2,5	3
⊕	2	2	2	2
m ~	4	4,2	4,4	5
⊠ K	0,7 - 2,25	0,7 - 2,4	1,75 - 3	1,75 - 4,4

d ₁	ST 3,5	[ST 3,9]	ST 4,2	ST 4,8
13	●	●	●	
16	●	●	●	●
19	●	●	●	●
22	●	●	●	
L 25	●	●	●	●
32	●	●	●	●
38			●	●
45				●
50				●

Hexagon head self-drilling screws

● **BN 14729** | Stainless steel

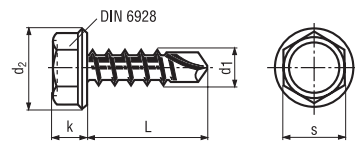

d ₁	ST 4,2	ST 4,8	ST 5,5	ST 6,3
d ₂ max.	8,8	10,5	11	13,2
k max.	4,25	4,45	5,45	6,45
s	7	8	8	10
⊠ K	1,75 - 3	1,75 - 4,4	1,75 - 5,25	2 - 6

d ₁	ST 4,2	ST 4,8	ST 5,5	ST 6,3
13	●	●		
16	●	●	●	
19	●	●	●	●
22		●		
25	●	●	●	●
32	●	●	●	●
L 35				●
38		●	●	●
45			●	●
50			●	
55			●	
65			●	
75			●	

Hexagon head self-drilling screws with sealing ring

● **BN 10319** | Stainless steel

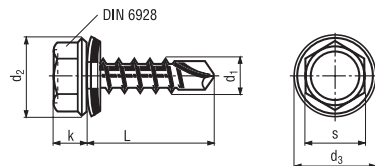

d ₁	ST 4,8	ST 5,5	ST 6,3
d ₂ max.	10,5	11	13,2
k max.	4,45	5,45	6,45
s	8	8	10
d ₃ ~	12,7	14,3	16
⊠ K	1,75 - 4,4	1,75 - 5,25	2 - 6

d ₁	ST 4,8	ST 5,5	ST 6,3
13	●		
16	●	●	
L 19	●	●	●
25	●	●	●
32		●	●
38			●

Subject to change without notice. Please refer to your local Bossard E-Shop for the current assortment and dimensions.
Other variants upon request.

PROVEN PRODUCTIVITY – A PROMISE TO OUR CUSTOMERS

The strategy for success

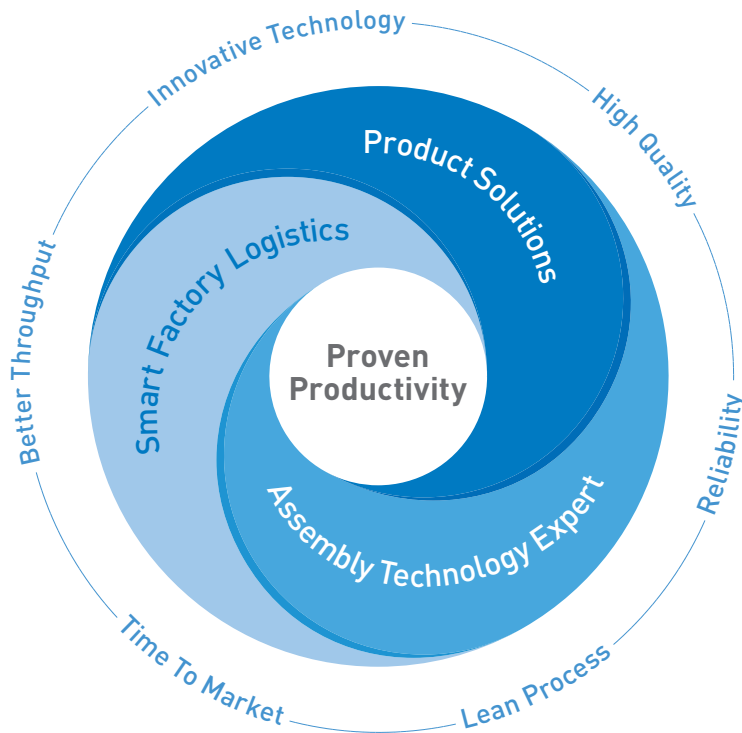

From years of cooperation with our customers we know what achieves proven and sustainable impact. We have identified what it takes to strengthen the competitiveness of our customers. Therefore we support our customers in three strategic core areas.

Firstly, when finding optimal **Product Solutions**, that is in the evaluation and use of the best fastening part for the particular function intended in our customers' products.

Second, our **Assembly Technology Expert** services deliver the smartest solutions for all possible fastening challenges. Our services cover from the moment our customers developing a new product, to

assembly process optimization as well as fastening technology education for our customers' employees.

And thirdly, optimising our clients' productions in a smart and lean way with **Smart Factory Logistics**, our methodology, with intelligent logistics systems and tailor-made solutions.

Understood as a promise to our customers, "Proven Productivity" contains two elements: Firstly, that it demonstrably works. And secondly, that it sustainably and measurably improves the productivity and competitiveness of our customers.

And this for us is a philosophy which motivates us every day to always be one step ahead.

www.bossard.com